

## AN ABSTRACT OF THE THESIS OF

Rozi Mohamed for the degree of Doctor of Philosophy in Forest Science presented on January 4, 2006.

Title: Expression and Function of *Populus* Homologs to *TERMINAL FLOWER 1* Genes: Roles in Onset of Flowering and Shoot Phenology.

Abstract approved: \_\_\_\_\_

Steven H. Strauss

Amy M. Brunner

We isolated and characterized the expression of two genes from *Populus trichocarpa* that are homologous to the *TERMINAL FLOWER 1* (*TFL1*) gene from the model annual plant *Arabidopsis*. In *Arabidopsis*, overexpression of the *TFL1* gene extends the vegetative growth phase, and the homozygous mutant *tfl1* allele causes early flowering and formation of a terminal flower. Overexpression of another *TFL1* family member, *FLOWERING LOCUS T* (*FT*), inhibits the action of *TFL1*. The two homologs studied, poplar *CENTRORADIALIS LIKE-1* (*PtCENL-1*) and poplar *MOTHER OF FT AND TFL1* (*PtMFT*), encode proteins that are 52% identical to one another; and 72% and 50% identical to *TFL1*, respectively.

Real-time RT-PCR studies revealed that *PtCENL-1* was expressed in all stages of development studied, and was most strongly expressed in vegetative buds and shoot apices. *PtMFT* was expressed preferentially in inflorescence buds. Expression patterns suggest that *PtCENL-1* promotes maintenance of the vegetative growth phase, and that *PtMFT* promotes the onset of flowering. We tested these hypotheses by overexpression of the *PtCENL-1/PtMFT* under the control of the CaMV 35S promoter (poplar and *Arabidopsis*), and via suppression of the endogenous genes via RNA interference (RNAi: poplar only).

Some *PtCENL-1* RNAi trees flowered during the second growing season in the field, several years earlier than expected. Floral buds were detected in four independent gene insertion events; in two of the four events, floral buds expanded into mature-appearing female catkins and dehisced, though seeds were not formed. All four events had native *PtCENL-1* transcript levels lower than in non-flowering events, and below 50% of the level detected in non-transgenic poplar. These early flowering events had normal budflush, however, 35S::*PtCENL-1* transcript levels were strongly and positively correlated with date of budflush. These results suggest that endogenous *PtCENL-1* is a natural inhibitor of the onset of flowering, and may also retard release from vegetative dormancy. Correspondingly, ectopic expression of *PtCENL-1* in *Arabidopsis* had delayed flowering. No phenotypic differences were observed in *PtMFT* overexpressing or RNAi transgenic trees. However, ectopic expression of *PtMFT* in *Arabidopsis* caused early flowering. Suppression of *PtCENL-1* might be useful for inducing early flowering in *Populus*.

©Copyright by Rozi Mohamed  
January 4, 2006  
All Rights Reserved

Expression and Function of *Populus* Homologs to *TERMINAL FLOWER 1* Genes:  
Roles in Onset of Flowering and Shoot Phenology

by  
Rozi Mohamed

A THESIS

submitted to

Oregon State University

in partial fulfillment of  
the requirements for the  
degree of

Doctor of Philosophy

Presented January 4, 2006  
Commencement June 2006

Doctor of Philosophy thesis of Rozi Mohamed presented on January 4, 2006

APPROVED:

---

Co-Major Professor, representing Forest Science

---

Co-Major Professor, representing Forest Science

---

Head of the Department of Forest Science

---

Dean of the Graduate School

I understand that my thesis will become part of the permanent collection of Oregon State University libraries. My signature below authorizes release of my thesis to any reader upon request.

---

Rozi Mohamed, Author

## ACKNOWLEDGEMENTS

I thank my major professors, Steve Strauss and Amy Brunner, for their supervision and support. I especially thank Dr. Strauss for supporting my return from Malaysia, making it possible to finish this thesis. He was instrumental in shaping my career development as a scientist. Dr. Brunner encouraged me to finish my thesis. She provided excellent research direction and technical advice when I reached a dead end. I am thankful to my committee for their involvement and advice. I thank Rick Meilan for helping with field work, and for serving on both my Masters and Doctoral committees. I am indebted to Sarah Dye for initial cloning and expression studies of the two poplar *TFL1* genes, and for sharing the genes with me. Her work made this project possible. I am grateful to Caiping Ma for assisting in transformation, overseeing the health of my trees, and supervising field work on my behalf. I thank Olga Shevchenko for her meticulous work on the *Arabidopsis* plants, photographing mutants, and generously sharing her experience in real-time RT-PCR. I thank Palitha Dharmawardhana for providing high-quality cDNA samples for the expression analyses. I also wish to thank Manuela Huso for helping with statistical analyses; Brian Stanton and Fort James Corporation (now known as Greenwood Resources) for allowing us to study the trees on their plantation; and Jace Carson for helping with tissue collection in the field. Finally, I wish to thank members of the Strauss Laboratory for sharing their experiences, helping me out in every possible way, and making my time here well-spent.

## CONTRIBUTION OF AUTHORS

Dr. Amy Brunner and Dr. Steve Strauss played a major role in writing the research proposal and papers, overseeing execution of the different parts of the project as a whole, providing advice over technical matters, and/or collecting tissue samples from the field. Sarah Dye cloned the two poplar *TFL1*-like genes described in Chapter 2, and conducted preliminary gene expression analyses. Caiping Ma and other members of the Strauss Laboratory assisted with poplar transformation, planting of the transgenic trees, growth measurements, and scoring of budflush, as described in Chapter 3. Olga Shevchenko did major work on phenotypic characterization of the *Arabidopsis* transformants, and assisted with RNA extractions and real-time RT-PCR, as described in Chapters 2 and 3. Dr. Richard Meilan took part in study design, managed the field study, and arranged for regulatory permits for planting of the transgenic trees, as described in Chapter 3. Dr. Palitha Dharmawardhana provided part of the RNA samples for expression analysis described in Chapter 3. This work was carried out in the laboratory of Dr. Steve Strauss at Oregon State University, Corvallis, Oregon, USA. Chapters 2 and 3 are in manuscript formats, and are aimed for publication in *Tree Physiology* and *The Plant Journal*, respectively.

## TABLE OF CONTENTS

	<u>Page</u>
Chapter 1: INTRODUCTION .....	1
POPLAR – A MODEL FOREST TREE .....	1
FLOWERING CONTROL FOR CONTRASTING NEEDS .....	2
FLORAL TRANSITION .....	3
<i>TFL1/FT</i> GENE FAMILY .....	6
MOLECULAR BIOLOGY OF FLORAL ONSET .....	9
Chapter 2: ISOLATION AND EXPRESSION OF <i>PtCENL-1</i> AND <i>PtMFT</i> , TWO <i>TERMINAL FLOWER 1</i> HOMOLOGS, IN <i>POPULUS</i> .....	11
ABSTRACT .....	11
INTRODUCTION .....	12
MATERIALS AND METHODS .....	13
RESULTS .....	20
DISCUSSION .....	29
Chapter 3: SUPPRESSION OF <i>PtCENL-1</i> , A <i>POPULUS</i> HOMOLOG OF <i>CENTRORADIALIS/TERMINAL</i> <i>FLOWER 1</i> , INDUCES EARLY FLOWERING IN FIELD-GROWN TRANSGENIC POPLAR.....	33
ABSTRACT .....	33
INTRODUCTION .....	33
MATERIALS AND METHODS .....	36
RESULTS .....	42
DISCUSSION .....	55

## TABLE OF CONTENTS (Continued)

	<u>Page</u>
Chapter 4: CONCLUSIONS .....	61
MAJOR RESULTS .....	61
MAJOR CONCLUSIONS .....	63
FUTURE RESEARCH SUGGESTIONS .....	63
BIBLIOGRAPHY .....	66
APPENDICES .....	72

## LIST OF FIGURES

<u>Figure</u>		<u>Page</u>
1	Pathways regulating the floral transition in <i>Arabidopsis</i> .....	4
2	Flowering cycle of poplar hybrids growing in the northwest of Oregon, USA, showing tissue collection at different times of the year .....	15
3	Structure of <i>PtCENL-1</i> and <i>PtMFT</i> genes, and similarity of their deduced amino acid sequences to several TFL1 homologs .....	21
4	<i>PtCENL-1</i> and <i>PtMFT</i> mRNA levels in vegetative (A) and floral organs (B) detected by real-time RT-PCR.....	26
5	<i>PtCENL-1</i> (A) and <i>PtMFT</i> (B) mRNA levels in a variety of poplar tissues sampled across a seasonal cycle, detected by real-time RT-PCR .....	28
6	Timing of flowering and transgene levels in <i>Arabidopsis</i> transformants .....	44
7	Ectopic expression of <i>PtCENL-1</i> in wild-type <i>Arabidopsis</i> .....	45
8	Early-flowering phenotypes of transgenic <i>Populus tremula</i> x <i>P. alba</i> carrying an RNAi construct for suppressing endogenous <i>PtCENL-1</i> expression.....	48
9	Close-up view of flowers of poplar hybrid carrying the <i>PtCENL-1</i> RNAi construct .....	51
10	Relative expression of native <i>PtCENL-1</i> in poplar transgenics carrying the <i>PtCENL-1</i> RNAi construct.....	52
11	Mean timing of budflush and mean net growth of field-grown transgenic <i>Populus tremula</i> x <i>P. alba</i> carrying four different constructs compared to non-transgenic controls .....	53
12	Relationship between <i>PtCENL-1</i> transgene overexpression and the timing of budflush in two-year-old, field-grown transgenic <i>Populus tremula</i> x <i>P. alba</i> .....	54

## LIST OF APPENDICES

<u>Appendix</u>	<u>Page</u>
A A LARGE-SCALE CTAB ISOLATION OF DNA FROM POPLAR LEAVES .....	73
B TOTAL RNA EXTRACTION PROTOCOL FOR POPLAR.....	77
C GENOMIC SEQUENCE OF <i>PtCENL-1</i> AND <i>PtMFT</i> .....	78
D DEDUCED AMINO ACID SEQUENCE ALIGNMENT OF DIFFERENT <i>TFL1</i> HOMOLOGS.....	81
E MEMBERS OF THE POPLAR <i>TFL1</i> GENE FAMILY .....	86
F RNA SOURCE, TISSUE TYPES, AND EXPRESSION DATA.....	87
G MEASURING RT-PCR VARIATION IN GENE EXPRESSION WITHIN A WIDE VARIETY OF TISSUE SAMPLES .....	90
H CONSTRUCT ASSEMBLY.....	92
I TRANSGENE DETECTION VIA PCR ANALYSIS .....	97
J SMALL-SCALE DNA EXTRACTION PROTOCOL FOR POPLAR.....	99
K PHENOTYPIC AND EXPRESSION DATA OF TRANSGENIC <i>ARABIDOPSIS</i> PLANTS.....	101
L LIST OF POPLAR TRANSGENICS .....	105
M CHARACTERIZATION OF TRANSGENIC POPLARS: GROWTH ASSESSMENT, TIMING OF BUDFLUSH, AND RELATIVE EXPRESSION OF TARGET GENES.....	106
N LOCATION OF PRIMERS, DNA AND RNA SAMPLES, AND ELECTRONIC FILES IN THE LABORATORY .....	122

## LIST OF APPENDIX FIGURES

<u>Figure</u>	<u>Page</u>
M 1 Relationship between the expression of native <i>PtCENL-1</i> (A) and the timing of budbreak (B) and growth (C) in two-year-old, field-grown transgenic <i>Populus tremula</i> x <i>P. alba</i> .....	114
M 2 Expression levels of native <i>PtCENL-1</i> transcript in biological replicates (different ramets) of selected HANNIBAL:: <i>PtCEN-1</i> trees and non-transgenic controls .....	115
M 3 Relationship between the expression of <i>PtCENL-1</i> transgene (A) and the timing of budbreak (B) and growth (C) in two-year-old, field-grown transgenic <i>Populus tremula</i> x <i>P. alba</i> .....	116
M 4 Relationship between the expression of native <i>PtMFT</i> (A) and the timing of budbreak (B) and growth (C) in two-year-old, field-grown transgenic <i>Populus tremula</i> x <i>P. alba</i> .....	118
M 5 Relationship between the expression of <i>PtMFT</i> transgene (A) and the timing of budbreak (B) and growth (C) in two-year-old, field-grown transgenic <i>Populus tremula</i> x <i>P. alba</i> .....	120
M 6 Relationship between <i>PtMFT</i> transgene overexpression and net growth in two-year-old, field-grown transgenic <i>Populus tremula</i> x <i>P. alba</i> .....	121

## LIST OF APPENDIX TABLES

<u>Table</u>	<u>Page</u>
F 1	Relative expression (RE) of native <i>PtCENL-1</i> and <i>PtMFT</i> in different tissue types ..... 87
F 2	Relative expression (RE) of native <i>PtCENL-1</i> and <i>PtMFT</i> in different tissue types collected across a seasonal cycle ..... 88
G 1	Summary on CV calculation for measuring variation in <i>UBQ</i> expression over different tissue types ..... 90
G 2	Summary on CV calculation for measuring variation in <i>PtCENL-1</i> and <i>PtMFT</i> expressions over different tissue types ..... 91
K 1	Mean and standard deviation (SD) of flowering time and number of rosette leaves in transgenic and wild-type <i>Arabidopsis</i> ..... 101
K 2	Relative expression (RE) and standard deviation (SD) of transgenes in representative transgenic events selected based on time of flowering ..... 104
M 1	Mean (natural logarithm) and standard error (SE) of the timing of budflush and tree growth for non-transgenic control and transgenic trees . 106
M 2	Mean and standard error (SE) of the timing of budflush and tree growth for non-transgenic control and transgenic trees ..... 106
M 3	Correlation analysis for variables relative expression of specific target genes and Julian date/net growth ..... 112
M 4	Relative expression (RE) of native <i>PtCENL-1</i> , mean of Julian date (JD), and mean of net growth (NG) in HANNIBAL:: <i>PtCENL-1</i> (HC) transgenic poplar trees..... 113
M 5	Relative expression (RE) of native <i>PtCENL-1</i> in biological replicates of the suppressed HANNIBAL:: <i>PtCENL-1</i> (HC) transgenic events ..... 113
M 6	Relative expression (RE) of native <i>PtCENL-1</i> , mean of Julian date (JD), and mean of net growth (NG) in 35S:: <i>PtCENL-1</i> (PC) transgenic poplar trees ..... 115
M 7	Relative expression (RE) of native <i>PtMFT</i> , mean of Julian date (JD), and mean of net growth (NG) in HANNIBAL:: <i>PtMFT</i> (HF) transgenic poplar trees ..... 117
M 8	Relative expression (RE) of <i>PtMFT</i> transgene, mean of Julian date (JD), and mean of net growth (NG) in 35S:: <i>PtMFT</i> (PM) transgenic poplar trees ..... 119

## DEDICATION

بِسْمِ اللَّهِ الرَّحْمَنِ الرَّحِيمِ

In the name of Allah, the Compassionate, the Merciful

I thank God for His guidance, and for giving me the strength to finish this thesis. I dedicate this thesis to my late father and my husband, two men of significant impact during two different stages of my life. Bapak taught me to persevere, to embrace fear, to be generous, and to accept being different is special and an advantage. Pierre, whose enduring love and continuing support help me to go through life's most difficult moments. To Adi and Irfan, I hope you are proud of Mama.

# **EXPRESSION AND FUNCTION OF *POPULUS* HOMOLOGS TO *TERMINAL FLOWER 1* GENES: ROLES IN ONSET OF FLOWERING AND SHOOT PHENOLOGY**

## **Chapter 1: INTRODUCTION**

### **POPLAR – A MODEL FOREST TREE**

The genus *Populus*, which includes poplars, cottonwoods and aspens, is grown for many commercial purposes such as wood products, fuel, pulp, and paper. Additionally, they are used as windbreaks for soil conservation, groundwater remediation, rehabilitation of riparian areas, to provide habitat for diverse animals, and for their aesthetic value to humans. The genus *Populus* contains 30 to 40 different species that are distributed widely over the Northern Hemisphere and subtropical regions (United Nations Food and Agriculture Organization, FAO, 1985). There are over 30 countries that grow and conduct research on poplars (FAO – International Poplar Commission, <http://www.efor.ucl.ac.be/ipc>). This reflects the global importance of poplar. In the United States (U.S.), poplar has been successfully cultivated in plantations in the Pacific Northwest (PNW), and the North Central and Southern regions (Wright and Berg, 1996). Because of their fast growth and easy propagation, poplars have been grown in plantations under short-rotations to provide a renewable source of biomass for energy, and to provide fiber for the pulp and paper industry (FAO, 1997; Zsuffa et al., 1996).

Besides economic value, poplars are also widely used as a model forest tree for molecular biology and biotechnology (Bradshaw et al., 2000; Taylor, 2002). Their attributes include ease of clonal propagation, rapid growth, amenability to transformation, a small genome size (550 Mb), extensive genome markers, and readily available mapping pedigrees (Bradshaw, 1998). Juvenility in some trees can last decades before the onset of flowering. Fortunately in poplars, the

vegetative phase lasts only several years, with flowering occurring as early as three to four years of age (Braatne et al., 1996). This makes poplar an excellent model for studying genetic controls on juvenile to mature (flowering) phase transition. Large genomics projects are currently underway at different research institutes worldwide, creating extensive genomic resources in poplar (reviewed in Brunner et al., 2004a). These include a large collection of expressed sequence tags (ESTs), microarray chips, and most importantly, the genomic sequence of *Populus* (Brunner et al., 2004a).

Through sequence information and expression profiles, gene function can be predicted by homology to genes in well-studied model plants, and tested in a model tree like poplar. Functional studies often include overexpression or suppression of a single candidate gene related to a specific trait of interest using transgenic approaches. Typically, suppression of gene expression is induced by double-stranded RNA (RNAi technology) (Waterhouse and Helliwell, 2003), and overexpression is achieved by using a strong promoter or enhancer.

## **FLOWERING CONTROL FOR CONTRASTING NEEDS**

The switch to flowering is a major developmental transition in the plant life cycle. In trees, different species flower at different ages, indicating that flowering occurs in response to internal developmental factors. By reaching a certain age and perhaps size, the adult vegetative meristems become competent to respond to floral induction, often by means of environmental stimuli such as photoperiod, temperature, and nutrients (Bernier et al., 1993; Yanovsky and Kay, 2003).

We sought to identify genes that control the vegetative-to-reproductive transition in poplar. These genes might be useful for accelerating or delaying flowering. Because trees have prolonged juvenility, accelerating the onset of flowering, for instance by genetic modification of flowering-promoting genes, could speed progress with breeding. Trees that fail to flower in plantations may be

highly desirable when exotic, highly domesticated, or genetically engineered trees are used in commercial settings. Not only would such trees come equipped with an inherent transgene-containment system, they might also grow faster by re-directing their energy into vegetative tissues.

Several characteristics of poplar make the use of transgenic or exotic poplars in production plantations a high ecological risk for dispersal. Poplars typically produce a large quantity of pollen and seed. The small seed size, and low effective density (seeds are cushioned in “cotton”), allow easy dispersal of seeds by wind and water. Such characteristics promote long-distance gene flow, creating ecological concerns for transgenes that carry traits such as insect and herbicide resistance (reviewed in James et al., 1998; DiFazio et al., 2004). Engineered transgene containment may reduce ecological concerns over transgene dispersal, and may, thus, encourage public acceptance.

## FLORAL TRANSITION

Initially, plants undergo a period of vegetative development, characterized by the repetitive production of leaves from the shoot meristem (Poethig, 1990). The shoot apical meristem (SAM) is a population of cells located at the tip of the shoot axis. It produces lateral organs and stem tissues, and regenerates itself. Later in development, the meristem undergoes a change in fate and enters reproductive growth. The phase change is controlled by both environmental and endogenous signals (reviewed in Simpson and Dean, 2002). Recent advances in genetic and molecular studies in model plant species such as *Arabidopsis* and *Antirrhinum* have led to proposals for four major genetic pathways involved in regulating reproductive transition (Figure 1). In the photoperiod promotion pathway, several phytochromes and cryptochromes perceive day length, which is mediated by the flowering time gene *CONSTANS* (*CO*) (reviewed in Hayama and Coupland, 2004). In the vernalization pathway, a long exposure to cold treatment induces flowering.

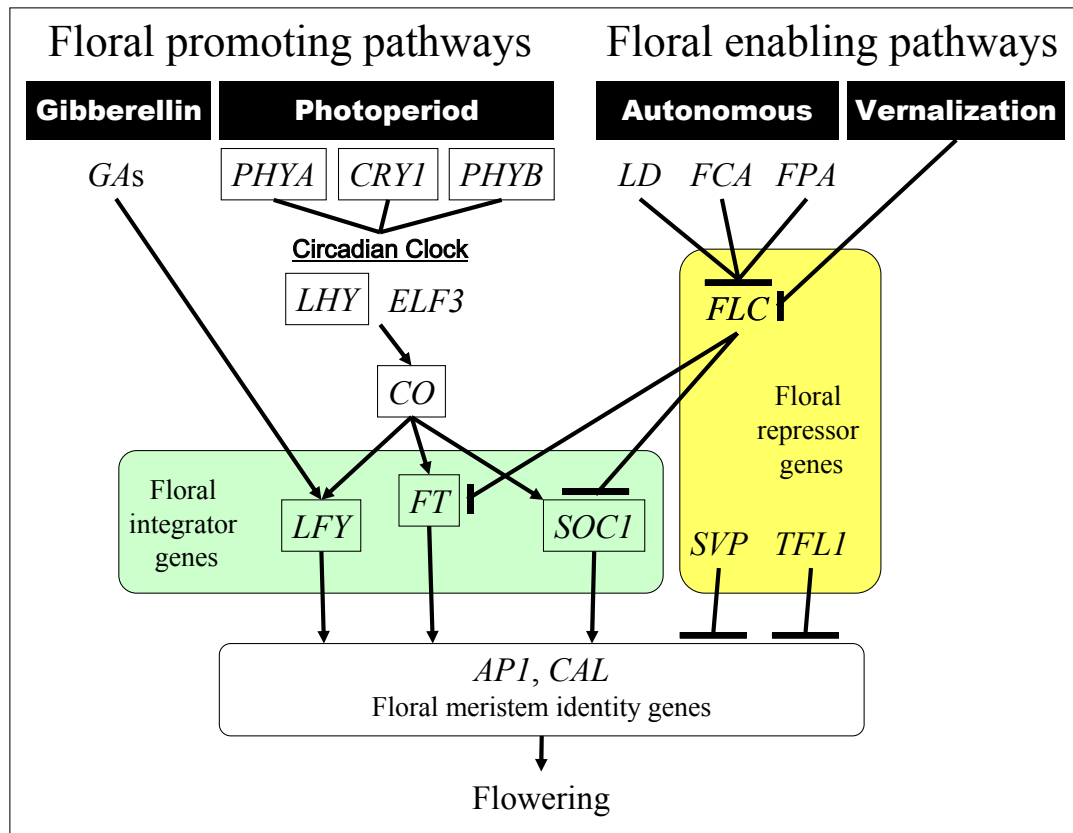

**Figure 1** Pathways regulating the floral transition in *Arabidopsis*. Long photoperiod and gibberellic acids (GA) promote the floral transition by activating the floral pathway integrators. The enabling pathways regulate flower competence of the meristems ability by regulating floral repressor activity such as the *FLOWERING LOCUS C (FLC)*. The model is derived from Brunner et al. (2003) and Boss et al. (2004). Arrows indicate activation and short lines indicate repression. Boxed genes indicate cloned poplar orthologs (Brunner et al., 2003).

Vernalization induced *VERNALIZATION INSENSITIVE3 (VIN3)*, a key gene that causes changes in the chromatin structure of a flowering repressor gene, *FLOWERING LOCUS C (FLC)*, maintains *FLC* in a repressed state. The mechanism of the vernalization-mediated epigenetic silencing of *FLC* has been reviewed in Sung and Amasino (2004). In the autonomous pathway, no external cues are needed; plants respond to endogenous cues to flower (for example, by reaching a certain size). The autonomous pathway appears to comprise multiple factors that regulate *FLC* in different ways. Factors that downregulate *FLC* mRNA include RNA binding proteins, such as *FCA* and *FPA*; and histone deacetylation proteins, like *FLD* and *FVE*, that regulate the *FLC* locus epigenetically (reviewed in Simpson, 2004). Lastly, the gibberellic acid (GA) pathway promotes flowering by GA mediating signaling, which in turn activates and upregulates floral meristem identity genes, which cause the formation of floral primordia. Integrator genes, at the intersection of these different pathways, regulate genes which control the transition to floral development in the meristem (reviewed in Simpson et al., 1999; Simpson and Dean, 2002).

Boss et al. (2004) proposed the concept of enabling and promoting pathways for flowering (Figure 1). The photoperiod pathway, for example, is a promoting pathway in which *CO* plays a key role that leads to the activation of the integrator genes upon receiving external stimuli, such as favorable photoperiodic conditions. Others include the pathways that mediate hormone biosynthesis and signaling, light quality, and ambient temperature signals. The different promoting pathways activate the expression of floral integrators. These include *FLOWERING LOCUS T (FT)*, *LEAFY (LFY)*, and *SUPPRESSOR OF OVEREXPRESSION OF CONSTANS (SOC1)*. In contrast, the enabling pathway regulates the meristems' competence to flower. One example is the *FLC* gene that plays a central role as a floral repressor. An abundance of *FLC* prevents flowering by inhibiting genes essential for the transition from vegetative to floral meristems. *TERMINAL FLOWER 1 (TFL1)* as well as *FLC* homologs, may be candidate floral repressor genes that influence enabling activity (Boss et al., 2004).

## ***TFL1/FT* GENE FAMILY**

*TFL1* encodes a protein that is similar to the mammalian phosphatidylethanolamine-binding proteins (PEBPs) and is highly homologous with *FT* (Bradley et al., 1997; Kardailsky et al., 1999; Kobayashi et al., 1999). *TFL1* extends the vegetative growth phase and maintains the indeterminate nature of the inflorescence. In contrast, *FT* promotes floral development. *TFL1* activity delays the upregulation of floral integrator gene, *LFY*, and the floral meristem identity genes *APETALAI* (*API*) and *CAULIFLOWER* (*CAL*), preventing floral transition in the meristem (Bradley et al., 1997; Ratcliffe et al., 1998). *LFY* and *API/CAL* inhibit *TFL1* expression in the floral meristems (Liljgren et al., 1999; Ratcliffe et al., 1999), indicating that *TFL1*, together with *LFY* and *API/CAL*, must be present in a specific ratio to influence flowering time (Ratcliffe et al., 1998, 1999). Homologs to *TFL1* have been cloned from many herbaceous plants, including the floral repressors *CENTRORADIALIS* (*CEN*) from *Antirrhinum* and *CET* (*CEN* homolog) from tobacco (Bradley et al., 1996; Amaya et al., 1999).

*FT* is a floral integrator that takes part in the long-day photoperiod pathway (Kobayashi et al., 1999; Kardailsky et al., 1999). Another major transcription factor operating under this pathway is encoded by *CO*, which induces *FT* expression to upregulate the expression of floral identity gene *API*, leading to flowering (Putterill et al., 1995; Suárez-López et al., 2001). *CO* and *FT* homologs in rice, *HEADING DATE 3-a* (*HD3a*) and *HEADING DATE 1* (*HDI*), respectively, promote the early-heading phenotype in rice under short days (Yano et al., 2001; Kojima et al., 2002). This suggests that the functions of some genes are conserved among species of divergent origin, such as the monocot rice and the dicot *Arabidopsis*. It is, therefore, plausible that they are also functionally conserved between annual plants and perennial trees.

Aside from *TFL1* and *FT*, there are four additional genes encoding PEBPs in the *Arabidopsis* genome, including *CEN* homolog in *Arabidopsis* (*ATC*), *BROTHER OF FT AND TFL1* (*BFT*), *MOTHER OF FT AND TFL1* (*MFT*), and

*TWIN SISTER OF FT (TSF)* (Kobayashi et al., 1999; Mimida et al., 2001). *ATC* acts similarly to *TFL1* when overexpressed, whereas overexpression of *TSF* and *MFT* leads to early flowering (Kobayashi et al., 1999; Mimida et al., 2001; Yoo et al., 2004; Yamaguchi et al., 2005).

### Expression patterns

In wild-type *Arabidopsis*, *TFL1* is expressed at high levels in the inflorescence apex, while the expression of *LFY* and *API1*, two *TFL1* antagonists, is observed in floral meristems on the periphery (Bradley et al., 1997). In *tfl* mutants, the antagonist genes are upregulated in the inflorescence apex meristems, speeding terminal flower formation. *CEN* is expressed in the same manner as *TFL1* in *Antirrhinum* (Bradley et al., 1996). Expression of *CET2* and *CET4*, two tobacco genes most similar to *CEN*, are restricted to axillary vegetative meristems (Amaya et al., 1999). *SELF-PRUNING (SP)*, the *CEN* homolog in tomato, is normally expressed in all meristems including axillary and floral, and in most primordia throughout development (Pnueli et al., 1998). However, in citrus trees, *TFL1* has not been detected in seeds and adult vegetative tissues, including roots, stems and leaves, although it is present in all four floral organs (Pillitteri et al., 2004). Apple *TFL1* has been detected in various vegetative tissues, excluding mature leaves (Kotoda and Wada, 2005); however, it has not been detected in floral organs. Its expression peaks in apical buds two weeks prior to floral bud differentiation. *Impatiens TFL1* is involved in controlling the phase of the axillary meristems and is expressed in axillary shoots and axillary meristems, which produce inflorescences, but not in axillary flowers (Ordidge et al., 2005).

*TFL1* expression has been studied in monocot species as well. Expression of a *TFL1* homolog in ryegrass occurs in most tissues under normal conditions (Jensen et al., 2001). However, its expression is suppressed in apical meristems after a cold treatment required for flower induction; subsequent exposure to long days and

higher temperatures induced expression to high levels. In ryegrass, the promoter of *TFL1*-like gene is found active in axillary meristems but not in apical meristems, reflecting its function in controlling axillary meristem identity as well as acting as a floral repressor (Jensen et al., 2001). In rice, *CEN* homologs are involved in secondary meristem activities, as suggested by their distinct expression patterns via *in situ* hybridization, and are weakly expressed in most tissues throughout rice development (Zhang et al., 2005).

*FT* is a floral integrator that is expressed in most aerial parts of the mature plant (Kardailsky et al., 1999). Appropriate day length allows the accumulation of the transcription factor *CO* that controls expression of *FT* in leaves. *FT* transcripts move through the phloem to the shoot apex, where the protein is translated. *FT* protein interacts with a bZIP transcription factor, *FD*, and together they activate key genes like *API* to start floral development. In addition, *FT* also upregulates *LFY* expression in the shoot apex to form flowers (Abe et al., 2005; Blázquez, 2005; Huang et al., 2005; Wigge et al., 2005).

### **Transgenic studies**

Overexpression of *TFL1* or *CEN* delays the transition to flowering and the formation of a terminal flower. It also greatly extends both vegetative and reproductive phases in *Arabidopsis* and tobacco, respectively, resulting in larger plants. The *tfl1* and *cen* mutant plants convert indeterminate inflorescences to determinate flowers (Amaya et al., 1999; Ratcliffe et al., 1999). *SP* (*SELF-PRUNING*) gene, which is a *CEN* homolog in tomato, controls sympodial indeterminate growth. The *sp* tomato mutant develops fewer nodes along the stem before forming a terminal flower, and changes the indeterminate flowers into determinate flowers on the branches (Pnueli et al., 1998). In rice, overexpression of rice *TFL1* homologs delays the transition to flowering. Transgenic rice also develops many branches and denser panicle morphology (Nakagawa et al., 2002).

Similar phenotypes, as observed in the 35S::*TFL1* transgenic *Arabidopsis*, were also seen in *Arabidopsis* when ectopically overexpressing *TFL1*-like genes from other plant species. These include ryegrass (Jensen et al., 2001), rice (Nakagawa et al., 2002), citrus (Pillitteri et al., 2004), apple (Kotoda and Wada, 2005), and *Impatiens balsamina* (Ordidge et al., 2005). Overexpression of a ryegrass *TFL1* homolog reverses the severe phenotype in a *TFL1* mutant of *Arabidopsis* (Jensen et al., 2001).

Overexpression of another member, *TSF*, promotes early flowering, while overexpression of yet another member, *ATC*, shows the opposite effect (Kobayashi et al., 1999; Mimida et al., 2001). *TSF* and *FT* share similar modes of regulation under long days, suggesting their action in promoting flowering could be redundant (Yamaguchi et al., 2005). *MFT* is one member of the PEBPs in *Arabidopsis*, whose function remains vague. Overexpression of *MFT* leads to early-flowering in *Arabidopsis*; however, an *MFT* mutant had normal flowering time (Yoo et al., 2004). This suggests that *MFT* functions as a floral inducer but that it could act redundantly with *FT* in determining flowering time (Yoo et al., 2004).

## MOLECULAR BIOLOGY OF FLORAL ONSET

Because trees have prolonged juvenility, accelerating the onset of flowering - for instance by genetic modification of flowering-promoting genes - could shorten breeding cycles. This holds true in the case of citrus, where the overexpression of *LFY* or *API*, two floral regulatory genes from *Arabidopsis*, accelerated flowering and induced normal fruits (Pena et al., 2001). *LFY* has been found to accelerate flowering in poplar as well; however, the transgenic trees were dwarfed, heavily branched, and did not produce normal seeds or pollen (Rottmann et al., 2000). Expression of a *TFL1* homolog in citrus has been found to be positively correlated with juvenility and negatively correlated with expression of the floral integrator genes *LFY* and *API* (Pillitteri et al., 2004). In poplar, an *FT*-like gene has been

cloned and overexpressed in transgenic plants (C. Yuceer, pers. comm.). In these transgenic trees, flowering was accelerated and a terminal flower was formed. In addition, vegetative and floral buds did not undergo dormancy under short- or long-day conditions. This suggests a relationship between dormancy control and floral meristem development mediated by poplar *FT*.

## Chapter 2: ISOLATION AND EXPRESSION OF *PtCENL-1* AND *PtMFT*, TWO *TERMINAL FLOWER 1* HOMOLOGS, IN *POPULUS*

### ABSTRACT

*TERMINAL FLOWER 1* (*TFL1*) is part of a small gene family that regulates the onset of flowering in *Arabidopsis*. We have cloned two *TFL1*-like genes from black cottonwood, *Populus trichocarpa*. *P. trichocarpa* CENTRORADIALIS-LIKE-1 (*PtCENL-1*) shared 77% amino acid identity with *Antirrhinum* CEN, while *P. trichocarpa* MOTHER OF FT AND TFL1 (*PtMFT*) shared 78% homology with MFT, another member of the TFL1 family in *Arabidopsis*. We used real-time reverse transcription PCR (RT-PCR) to assess the expression patterns of the two genes in various tissue samples collected at different times of the year. Both genes transcripts were detected in all tissues throughout poplar development, except that *PtMFT* transcripts were absent from vascular tissues. *PtCENL-1* was chiefly expressed in vegetative buds, while *PtMFT* was chiefly expressed in inflorescence buds. *PtCENL-1* expression was weak in dormant buds, but it was upregulated in post-dormant buds and climaxed when the buds burst, after which it decreased drastically as the young leaves expanded. *PtMFT* expression was weaker than that of *PtCENL-1* in all tissues tested. In contrast, *PtMFT* expression was suppressed during budburst, and it was upregulated when vegetative buds and inflorescence buds entered dormancy. The contrasting expression of these two genes suggests that they might act antagonistically in regulating flowering in poplar, in similar manners to *TFL1* and *FT* in *Arabidopsis*.

## INTRODUCTION

The genes that control the onset of flowering in trees are unknown. However, model plant systems provide candidate genes for studying developmental genes in trees. A key gene that affects the developmental phases and inflorescence architecture in the annual plant *Arabidopsis* is *TERMINAL FLOWER 1 (TFL1)* (Bradley et al., 1997). *TFL1* regulates flowering by delaying the time of flowering, thus extending vegetative growth (Bradley et al., 1997). *TFL1* homologs have been cloned from many plant species. *CENTRORADIALIS (CEN)* is a *TFL1* homolog in *Antirrhinum* (Bradley et al., 1996), and *CET* is a *CEN* homolog in tobacco (Amaya et al., 1999). Overexpression of *TFL1* or *CEN* delays the transition to flowering and the formation of a terminal flower. It also greatly extends both vegetative and reproductive phases in *Arabidopsis* and tobacco, respectively, resulting in larger plants. The *tfl1* and *cen* mutant plants show conversion of their normally indeterminate inflorescences to determinate flowers (Amaya et al., 1999; Ratcliffe et al., 1999). *SELF-PRUNING (SP)*, which is a *CEN* homolog in tomato, controls sympodial indeterminate growth. The *sp* tomato mutant develops fewer nodes along the stem before forming a terminal flower, and has conversions of indeterminate flowers to determinate flowers on its branches (Pnueli et al., 1998).

*TFL1/CEN* encode proteins belonging to the family of the mammalian phosphatidylethanolamine-binding proteins (PEBPs). The proteins are kinases that have been demonstrated to be regulators in signaling pathways (Yeung et al., 1999; Banfield and Brady, 2000). Another member is *FLOWERING LOCUS T (FT)*, which encodes a protein with opposing effects to that of *TFL1* (Kardailsky et al., 1999). *FT* is a floral promoter that takes part in the long-day photoperiod pathway (Kardailsky et al., 1999; Kobayashi et al., 1999).

In wild-type *Arabidopsis*, *TFL1* is expressed at high levels in the inflorescence apex, while the expression of *LFY* and *API*, two *TFL1* antagonists, is observed in young floral meristems on the periphery of the apex (Bradley et al., 1997). *CEN* is expressed in the same manner as *TFL1* in *Antirrhinum* (Bradley et al., 1996).

Expression of *CET2* and *CET4*, two tobacco genes most similar to *CEN*, is restricted to axillary vegetative meristems (Amaya et al., 1999). *SP* is normally expressed in all meristems and most primordia throughout development (Pnueli et al., 1998). *FT* is expressed in most aerial parts in mature plants (Kardailsky et al., 1999).

We chose to study *TFL1/FT*-like genes because of their ability to accelerate or modify flowering in a variety of plant species. They could provide useful tools for tree breeding via early onset of flowering, or for gene containment by postponing flowering. We cloned poplar homologs of *CEN* and *MOTHER OF FT AND TFL1 (MFT)* genes, two members of the *TFL1/FT* family that affect the vegetative-to-reproductive transition in *Antirrhinum* and *Arabidopsis*, respectively. Because trees are long-lived organisms and temperate-zone trees depend on seasonal changes to induce dormancy and flowering, we studied expression patterns of both genes in a variety of tissues collected during different seasons times from field-grown trees.

## **MATERIALS AND METHODS**

### **Plant materials and tissue collection**

For gene cloning, female inflorescence buds were collected in spring 2000 from wild cottonwood (*Populus trichocarpa*) growing in the vicinity of Corvallis, Oregon (OR), USA. For expression in different organs, tissue samples were collected in 2004. Female flowers were collected post-pollination, while male flowers were collected after they had fully developed in March. Newly-initiated female and male inflorescence buds were collected in June. Vegetative tissues were collected in April and June, including vegetative shoots (less than 3 cm long; no expanded leaves), shoot apices, new vegetative buds, and mature leaves. Xylem and phloem (including the cambium) were sampled from a two-year-old, actively

growing *P. trichocarpa* clone Nisqually-1 in August 2004, located near Corvallis. The bark was peeled and three- to six-cell layers from the bark side representing developing phloem/cambium, and the wood side representing developing xylem, were scraped into liquid nitrogen. Seedlings were germinated from wild cottonwood seeds in the lab at room temperature by placing surface-sterilized seeds on filter paper soaked with sterile water in Petri dishes. The Petri dishes were then incubated for 24 hr in the dark, and subsequently exposed to light under a 16-hr photoperiod. Light was provided by fluorescent tubes (TL70, F25T8/TL735, Philips) at a photon flux density of  $45 \mu\text{Em}^{-2}\text{s}^{-1}$ . The seedlings were sampled 43 hr post imbibition.

For studying expression patterns, a total of seven tissue types were collected from one- to six-yr-old (R1 to R6, respectively) hybrid poplar trees (*P. trichocarpa* x *P. deltoides*, clone 15-29) grown in a poplar plantation near to Clatskanie, OR, at different times of the season in 2001 (Figure 2). Terminal and lateral vegetative buds (TVB and LVB, respectively) were collected in early spring (March 20 and April 3); in the middle of summer (August 7); and in early fall (October 15). Bud scales were removed and tissues were frozen in liquid nitrogen and stored at  $-80^\circ\text{C}$ . Newly-flushed young leaves from terminal and lateral vegetative buds (FTV and FLVB, respectively) that just emerged from dormancy were collected in early spring (April 18). Young actively growing shoot tips (ST) were removed in spring (May 5 and June 19). Mature inflorescence floral tissues (MF) were collected early in the season (March 3) and again at full bloom (April 3). New inflorescence buds (IB) initiated for next year's blooming season were collected in summer (August 7) and fall (October 15). All samples were pruned from the tree upper crowns, except R6B samples, which were taken from the lower crowns. All tissues were frozen in liquid nitrogen and stored at  $-80^\circ\text{C}$ .

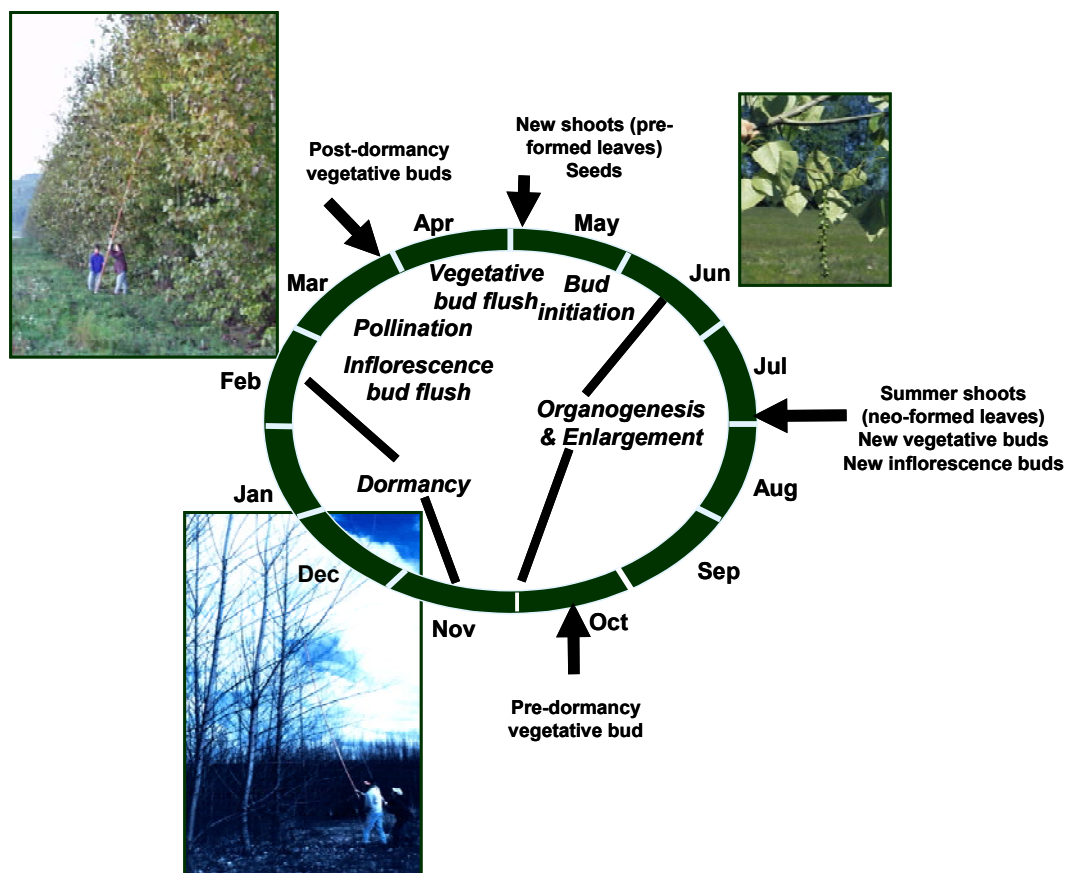

**Figure 2** Flowering cycle of poplar hybrids growing in the northwest of Oregon, USA, showing tissue collection at different times of the year. All tissue samples were obtained from poplar hybrid trees, *Populus trichocarpa* x *P. deltoides* (female clone 15-29), grown in a plantation near Clatskanie, Oregon, USA. Samples were collected from one- or two-yr-old juvenile trees, and from five- or six-yr-old mature trees during the indicated times of the year in 2001.

### Cloning of poplar *PtCENL-1* and *PtMFT* genes

Degenerate primers were designed based on the conserved motifs of amino acid sequences of several *TFL1* genes including *Nicotiana tabacum CEN-L* (*NtCET2*, AAD43529), *Lycopersicon esculentum SP (LeSP)*, AAC26161); *Antirrhinum majus CEN* (*AmCEN*, CAC21563); *Arabidopsis thaliana TFL1* (*AtTFL1*, AAB41624); *Oryza sativa CEN-L (OsFDRI)*, AAD42896); and *Brassica napus TFL1 (BnTFL1-1)*, BAA33415). The partial cDNA of *PtCENL-1* was amplified via PCR from a cDNA template of female inflorescence buds. A gradient thermalcycler was used to optimize annealing temperature using degenerate primers APTFL-1F (5'-AARCAIGTYTAYAATGGICATGA-3') and APTFL-1R (5'-GTYTCICICTGRCARTTGAAGAA-3'). Successful amplification occurred under the following conditions: 94 °C for 4 minutes; 30 cycles of 1 minute each at 94 °C, 45 seconds at 50 °C, 1 minute at 72 °C; final extension of 72 °C for 10 minutes. The PCR product was diluted 1:100 and used as template in nested PCR with APTFL-2F (5'-CCIGATGTICCIIGGICCIAGTGA-3') and APTFL-2R (5'-TTGAAGAAIACIGCIGCIACIGG-3') primers. Thermalcycler parameters were as follow: 94 °C for 4 minutes; 20 cycles of 1 minute each at 94 °C, 45 seconds at 50 °C, 1 minute at 72 °C; final extension of 72 °C for 10 minutes.

The partial cDNA of *PtMFT* was amplified via PCR also using the same cDNA from female inflorescence buds. An oligo-dT primer was used along with a degenerate primer TFL-06F (5'-GTIRTIGGIGAIGTTITTGA-3'). Thermalcycler parameters were as follow: 94 °C for 4 minutes; 30 cycles of 1 minute each at 94 °C, 45 seconds at 56 °C, 1 minute at 72 °C; final extension of 72 °C for 10 minutes. The PCR product was diluted 1:100 and used in another round of amplification using degenerate primers TFL-07F (5'-ATGAYIGAYCCIGAYGTICC-3') and TFL-04R

(5'-AARIAIACIGCIGCIACIGG-3'). PCR conditions were as follow: 94 °C for 4 minutes; 20 cycles of 1 minute each at 94 °C, 45 seconds at 56 °C, 1 minute at 72 °C; final extension of 72 °C for 10 minutes. Taq polymerase was added only when initial heating began (94 °C for 4 minutes).

Full-length genomic clones of *PtCENL-1* and *PtMFT* were obtained by amplifying the 5' and 3' ends using the Genome Walker Kit (Clontech, Palo Alto, CA, USA) following the manufacturer's protocol. Genomic DNA from *P. trichocarpa* was isolated using a modification of the CTAB method, and used as the template (<http://zircote.forestry.oregonstate.edu/tgbb/protocols/extract.htm>; Appendix A). Primers were designed based on the obtained partial cDNA clones. *PtCENL-1* primers were GWATC1F (5'-AGGCCTAACATAGGGATCCACAGGTTT-3') nested with GWATC2FN (5'-ACAGGGCCACTTCAGCTTCAAGGACAA-3'). *PtMFT* primers were GWMFT1F (5'-CGCTACATACTGGTGCTTTTCCAGTAGAA-3') nested with GWMFT2FN (5'-GGAACCACCGCAGAACCGTTCTCATTTCA-3'). All clones were ligated into pGEM<sup>®</sup>-T Easy Vector (Promega, Madison, WI, USA). All PCR products were sequenced at the Oregon State University, Center for Gene Research and Biotechnology, Central Services Laboratory.

### **RNA extraction and cDNA synthesis**

Total RNA was extracted from plant materials using a modified protocol for poplar combined with the RNeasy Mini Kit (Qiagen, Valencia, CA, USA) (<http://zircote.forestry.oregonstate.edu/tgbb/protocols/PoplarRNAextraction.pdf>; Appendix B) and then treated with DNase (DNA-free kit, Ambion, Austin, TX, USA). A total of 1 µg of DNase-treated RNA was reverse-transcribed in vitro using the SuperScript<sup>™</sup> First-Strand Synthesis System for RT-PCR (Invitrogen, Carlsbad, CA, USA), following the manufacturer's instructions. The cDNA mixture was diluted five-fold and used directly in real-time PCR.

cDNA samples of the various organs were provided by Dr. Palitha Dharmawardhana in the Department of Forest Science, Oregon State University. cDNA was transcribed from 1 µg of total RNA using the SuperScript™ III First-Strand Synthesis System for RT-PCR (Invitrogen, Carlsbad, CA, USA) in a 20 µl reaction volume following the manufacturer's protocol. The cDNA mixture was diluted five-fold and used directly in real-time PCR.

To establish a standard curve for RT-PCR efficiency determination, cDNA from a sample identified in preliminary real-time PCRs as having high levels of the target gene transcripts, was diluted serially five to six times using five-fold dilutions. The diluted cDNAs were used as standard templates and run together with unknowns in each real-time PCR plate.

### **Real-time reverse transcription PCR (RT-PCR)**

RT-PCR was carried out to detect the levels of endogene *PtCENL-1* and *PtMFT* transcripts in the various tissues. Gene-specific primers were designed using the Primer 3 software available at [http://frodo.wi.mit.edu/cgi-bin/primer3/primer3\\_www.cgi](http://frodo.wi.mit.edu/cgi-bin/primer3/primer3_www.cgi) (Rozen and Skaletsky, 2000). Forward and reverse primers used for the detection of *PtCENL-1* were 5'-CCTTTTTCACCCTGGTCATGA-3' and 5'-CAGTGTAGGTGCTCCCTGAGGTA-3'. For *PtMFT*, the primers were 5'-CGAGGGAAAGAGATCCTTTCCT-3' and 5'-AAAGCACCAGTATGTAGCGATGAA-3', and for the poplar polyubiquitin gene (*UBQ*), they were 5'-TGTACTCTTTTGAAGTTGGTGT-3' and 5'-TCCAATGGAACGGCCATTAA-3'. The resulting product sizes were 76, 73, and 75 bp, respectively.

RT-PCR was performed in a 25 µl final volume composed of 12.5 µl of Platinum® SYBR® Green qPCR SuperMix-UDG (Invitrogen, Carlsbad, CA, USA), 0.4 µM each of forward and reverse primers, and 1 µl of the cDNA reaction

mixture as template. Reactions were setup in 96-well plates and analyzed using the MX3000P™ Real-time PCR System (Stratagene, La Jolla, CA, USA). All plates contained duplicate PCR reactions per unknown sample, and triplicate PCR reactions per serially diluted standards, for both gene of interest and reference gene. Real-time PCR was conducted twice on all cDNA samples (one reverse transcription per tissue sample), except in seasonal expression studies, where it was conducted only once.

The threshold cycle (Ct) – the cycle at which product amplification is significantly above background signal – was determined using the MX3000P™ RT-PCR System software (version 2). A control/calibrator sample, usually a sample with the lowest expression, was selected for relative quantification. The Ct difference between unknown and control samples ( $\Delta C_{t_{\text{control} - \text{sample}}}$ ) is transformed into relative quantity (RQ), and corrected based on specific gene's RT-PCR efficiency ( $E$ ), using the formula,  $RQ = E^{(\Delta C_{t_{\text{control} - \text{sample}}})}$  (Pfaffl, 2001).  $E$  values are calculated from the slope of the standard curves following (Bustin, 2000):  $E = 10^{(-1/\text{slope})}$ . To correct for differences in template input across wells, a reference gene was included in all real-time PCR experiments. We chose the ubiquitin (*UBQ*) gene as the internal control because poplar *UBQ* is stably expressed in a variety of tissues (Brunner et al., 2004b). Normalized relative quantity of the target gene is calculated as  $RQ_{\text{target}}/RQ_{\text{reference}}$ . Normalization, calibration, re-scaling and standard deviation calculations were performed using the qBASE software version 1.2.2 (Hellemans et al., in preparation; <http://medgen.ugent.be/qbase>).

### Database search

*TFL1/FT/CEN* homologs were identified from public databases at the National Center for Biological Information (NCBI, <http://www.ncbi.nlm.nih.gov>) and The Institute for Genomic Research (TIGR, <http://www.tigr.org>). Poplar *TFL1* homologs were identified from the poplar genome sequence database at the United

States Department of Energy, Joint Genome Institute (DOE-JGI, [http://shake.jgi-psf.org/Poptr1\\_1/Poptr1\\_1.home.html](http://shake.jgi-psf.org/Poptr1_1/Poptr1_1.home.html)). All homologs were identified using the BLAST program available at each website, and their protein sequences were aligned using the CLUSTALW program (<http://align.genome.jp>). Phylogenetic relationships between the different TFL1/FT/CEN-like proteins were depicted in a neighbor-joining tree using the software MEGA 2 (Kumar et al., 2001).

## RESULTS

### Isolation of *TFL1*-like genes from poplar

Two *TFL1*-like genes, *P. trichocarpa* *CENTRORADIALIS-LIKE-1* (*PtCENL-1*) and *P. trichocarpa* *MOTHER OF FT AND TFL1* (*PtMFT*) were cloned from poplar by homology. The two genes were PCR-amplified from a cDNA pool of poplar inflorescence buds using degenerate primers derived from conserved motifs of aligned nucleotide sequences of several known *TFL1* homologs. The full-length coding sequence of *PtCENL-1* (GenBank, AY383600) is 525 bp, and *PtMFT* (GenBank, DQ310725) is 522 bp. A genomic walk, using specific *PtCENL-1* and *PtMFT* primers, revealed their entire genomic sequence (Figure 3A, Appendix C), which spanned 0.9 kb and 2.2 kb, respectively. Comparisons between cDNA and genomic sequences showed the existence of four exons and three introns, an organization identical to other *TFL1* homologs. Length of the spacers varied between the two genes; *PtMFT* was considerably longer than *PtCENL-1* due to a much longer third intron. Comparisons between translated coding sequence of both genes and known TFL1 proteins showed conserved intron positions among the two groups (Figure 3B). All six amino acids identified by Banfield and Brady (2000) as ligand-binding sites in *Antirrhinum majus* CEN (*AmCEN*) are conserved in *PtCENL-1*, while only three residues are conserved in *PtMFT* (Figure 3B). One of

**Figure 3** Structure of *PtCENL-1* and *PtMFT* genes, and similarity of their deduced amino acid sequences to several TFL1 homologs. A) Genomic organization of *PtCENL-1* and *PtMFT*. Filled boxes represent partial 5'- and 3'-untranslated regions (UTRs). Open boxes and lines represent exons and introns, respectively, at indicated lengths. Translational start codon begins at position 1. B) Amino acid sequence comparison between *PtCENL-1/PtMFT* and different TFL1 homologs. Identical residues are in black; conserved in gray. Dashes indicate gaps introduced for optimizing the alignment. Triangles denote identical intron positions. Filled circles indicate residues forming the ligand-binding sites identified in *AmCEN* (Banfield and Brady, 2000). Open circle indicates the residue which, upon mutation, switches *AtTFL1* function from a flower repressor to activator, and vice versa for *AtFT* (Hanzawa et al., 2005). C) A neighbor-joining tree of TFL1/FT-like proteins from *Populus* (two cloned genes from poplar are boxed and in bold) and different plant species. Numbers at the branching nodes indicate the % from 1,000 bootstrap replicates. GenBank accession numbers: *Nicotiana tabacum* CEN-L (*NtCET2*, AAD43529); *Lycopersicon esculentum* SP (*LeSP*, AAC26161; *LeSPG2*, AA031791); *Antirrhinum majus* CEN (*AmCEN*, CAC21563); *Arabidopsis thaliana* CEN, TFL1, BFT, TSF, FT, and MFT (*AtCEN*, NP\_180324; *AtTFL1*, AAB41624; *AtBFT*, Q9FIT4; *AtTSF*, NP\_193770; *AtFT*, BAA77838; *AtMFT*, NP\_173250); ***Populus trichocarpa* CENL-1 and MFT (*PtCENL-1*, AAQ88444; *PtMFT*, DQ310725)**; *P. nigra* FT1b and TFL1d (*PnFT1b*, BAD08338; TFL1d (*PnTFL1d*, BAD01610); *Oryza sativa* CEN-L (*OsCEN3*, BAD28412; *OsCEN4*, CAD40659; *OsFDR1*, AAD42896; *OsFDR2*, AAD42895); *Oryza sativa* FT-L (*OsFTL-1*, CAD41333; *OsHD3a*, BAC21280; *OsRFT1*, BAB78480); *Oryza sativa* TFL1 (*OsTFL1*, BAD45362); *Lolium perenne* TFL1 (*LpTFL1*, AAG31808); *Pisum sativum* TFL1a (*PsTFL1a*, AAR03725); *Citrus sinensis* TFL (*CsTFL*, AAR04683); *Brassica rapa* TFL1-1 (*BrTFL1-1*, BAA33418); *B. napus* TFL1-1 and 3 (*BnTFL1-1*, BAA33415; *BnTFL1-3*, BAA33417); *C. unshiu* FT (*CuFT*, BAA77836); *Malus domestica* FT (*MdFT*, BAD08340); and *P. deltoides* FT1 (*PdFT1*, AAS00056). DOE-Joint Genome Institute designation for *P. trichocarpa* homologs: CENL-2 and 3 (*PtCENL-2*, grail3.0001004901; *PtCENL-3*, eugene3.00151192); FTL-1, 2, 3 and 4 (*PtFTL-1*, fgenes4\_pg.C\_scaffold\_1444000001; *PtFTL-2*, fgenes4\_pg.C\_LG\_VIII000671; FTL-3, eugene3.14090001; FTL-4, fgenes4\_pm.C\_LG\_X000701). Alignment was performed using the CLUSTALW program.

A)

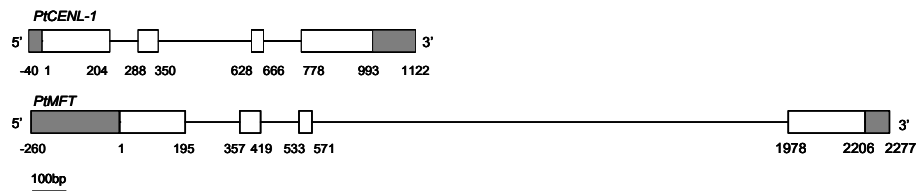

B)

```

AmCEN      : ---MAAKTSSDPLVIGRVIGDVVDHETSTVKMSVIYNANNSIKHVYNGHE : 47
AtCEN      : ---MARTSSDPLMVGRVIGDVVDNCLQAVKMTVTYNSD---KQVYNGHE : 43
AtFT       : ---MSINIR-DPLIVSRVVGVDVLDPENRSITLKVTYGQ---REVINGLD : 42
AtMFT      : ---MAASV--DPLVVGRVIGDVLDMP IPTANMSVYFGP---KHITNGCE : 41
AtTFL1     : MENMGTRVI-EPLIMGRVVGVDLDFETPTTKMNVSYNK---KQVSNNGHE : 45
PtCENL-1   : ---MAKMS-EPLVVGRVIGDVVDHETANVKMTVTYQSNR---KQVFNNGHE : 43
PtMFT      : ---MAASV--DPLVVGRVIGDVVDMPVPAVKMSVYVYGS---KHVSNNGCD : 41
CsTFL      : ---MAARML-EPLAVGGVIGDVVIESETPSIKMSVTYDN---KQVCNNGHE : 42

```

```

AmCEN      : LPSAVTSTPRVEVHGGDMRSEFTLIMTDPDVPGPSDFYLREHLHWIVTD : 97
AtCEN      : LPSVVTYKPKVEVHGGDMRSEFTLVMTDPDVPGPSDFYLREHLHWIVTD : 93
AtFT       : LRPSQVQNKPRVEIGGEDLRNFYTLVMVDPDVPSPSNPHLREYHLHWLVTD : 92
AtMFT      : IKPSTAVNPPKVNISGHS-DELYTLVMTDPDAPSPSEPNMREVVHWIVVD : 90
AtTFL1     : LPSVSVSSKPRVEIHGGDLRSEFTLVMTDPDVPGPSDFLKEHLHWIVTN : 95
PtCENL-1   : LPSAVTHKPKVEVHGGDMRSEFTLVMTDPDVPGPSDFYLREHLHWIVTD : 93
PtMFT      : IKPSLSVDPPKVTISGHS-DELYTLVMTDPDAPSPSEPRMREVVHWIVAD : 90
CsTFL      : LPSVTVSKPRVEIQGGDMRSEFTLVMTDPDVPGPSDFYLREHLHWIVTD : 92

```

```

AmCEN      : IPGTTDSSFGKEVVSYEIPRENI GIHRFVFLLFKQKR-GQAMLSPPVVC : 146
AtCEN      : IPGTTDVSFGKEIIGYEMPRENI GIHRFVYLLFKQTRR-GSVVSV--SY : 140
AtFT       : IPATTGTFEGNEIVCYENPSPTAGIHRVVFILFRQLGR--QTVYAP--GW : 138
AtMFT      : IPGCTNPSRCKEILPYMEPRPVG IHRVILVLFQNSPVGLMVQQP--PS : 138
AtTFL1     : IPGTTDATEFGKEVVSYEIPRPSI GIHRFVFLVFRQKR---RVIFPNIPS : 142
PtCENL-1   : IPGTTDATEGREVMNYEMPRENI GIHRFVFLLFKQKR--QVTTP--AS : 139
PtMFT      : IPGCTNPTRGKEILSYVGP RPVG IHRVILVLFQCKMPLGSMVEPP--QN : 138
CsTFL      : IPGTTDATEFGRELVSYEIPRENI GIHRFVFLVFKQTRR--QTVNPP--SS : 138

```

```

AmCEN      : RDGFNTRKFTQENELGLPVAAVFVNCQORETA--ARRR----- : 181
AtCEN      : RDQFNTRFAHENDLGLPVAAVFVNCQORETA--ARRR----- : 175
AtFT       : RQFNTRFAEIYNLGLPVAAVFYNCQORESGCGGRR----- : 175
AtMFT      : RANESTRMFAGHFDLGLPVAIVYFNAQKEPA--SRRR----- : 173
AtTFL1     : RDHFNTRKFAVEYDLGLPVAAVFVNAQORETA--ARKR----- : 177
PtCENL-1   : RDKNTRKFAEENELGLPVAAVFVNAQORETA--ARKR----- : 174
PtMFT      : RSHFNTRLYAAHLDLGLPVAIVYFNAQKEPA--NKRR----- : 173
CsTFL      : RDHFNTRFAAENDLGLPVAAVFYFNAQORETA--ARRR----- : 173

```

Figure 3 (A and B)

C)

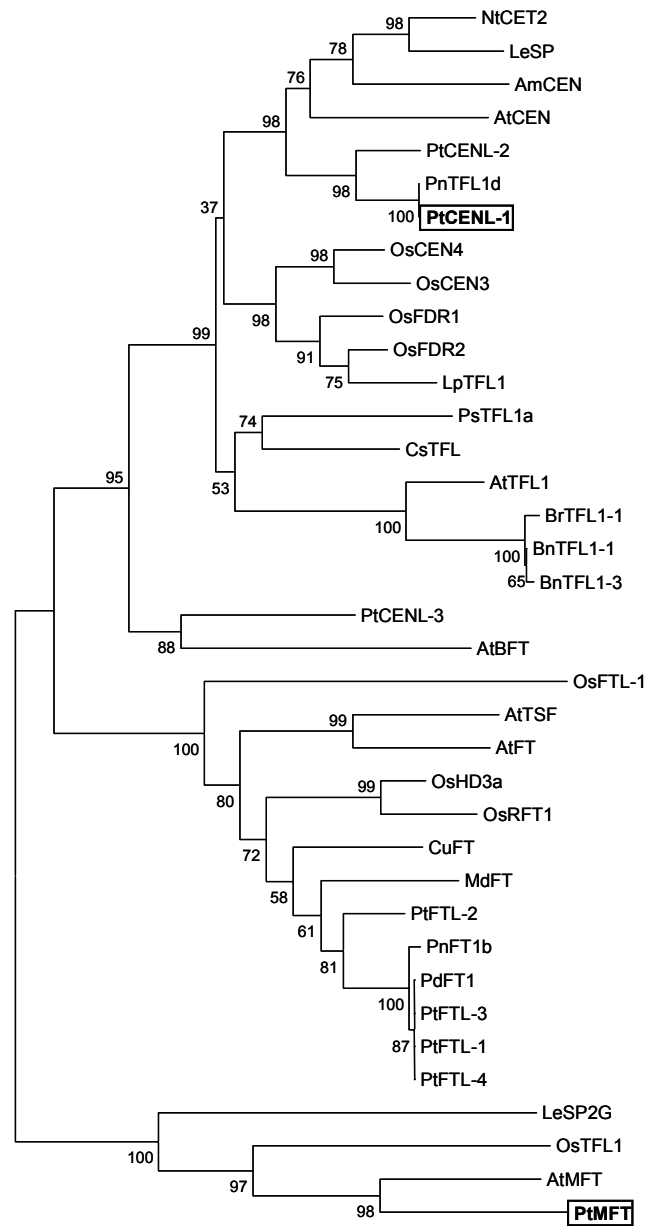

Figure 3 (C)

the residues, histidine (H)-88 in *Arabidopsis thaliana* TFL1 (*AtTFL1*), upon swapping with tyrosine (Y)-85 in *A. thaliana* FT (*AtFT*), converts functions of the two proteins reciprocally; *AtTFL1* became a floral promoter while *AtFT* became a repressor, as demonstrated by Hanzawa et al. (2005). At the corresponding sites in *PtMFT*, and its closest relative *AtMFT*, histidine is substituted by a tryptophan (W-83).

*PtCENL-1* and *PtMFT* each encoded a protein of 19 kD, consisting of 174 and 173 amino acid residues, respectively. Between the two of them, there were only 52% amino acid identity. *PtCENL-1* shared the highest identity with *Malus domestica* *MdTFL1* (79%) and *Nicotiana tabacum* *CET2* (79%), followed by *Oryza sativa* CEN-like proteins (76-79%), *AmCEN* (77%) and *AtTFL1* (72%). It shared the lowest homology with *AtMFT* (50%) followed by other FT and FT-like proteins: *AtFT* (56%), *AtTSF* (56%), and *AtBFT* (61%) (Figure 3C, Appendix D). In contrast to *PtCENL-1*, *PtMFT* shared the highest homology with *AtMFT* (78%), but the lowest homology with *AtFT* (45%) and *AtTFL1* (50%). A phylogenetic tree of TFL1/FT family members from different plant species indicated that *PtCENL-1* groups together with TFL1/CEN-like proteins, and *PtMFT* with *AtMFT* (Figure 3C). *TFL1* and *FT* are two important flowering-time regulators in *Arabidopsis* with antagonistic effects. Overexpression of *TFL1* keeps plants in vegetative state and at the same time suppresses transition to flowering (Ratcliffe et al., 1998), while *FT* overexpression expedites the transition reproductive growth (Kardailsky et al., 1999).

Database searches of the poplar genome ([http://shake.jgi-psf.org/Poptr1\\_1/Poptr1\\_1.home.html](http://shake.jgi-psf.org/Poptr1_1/Poptr1_1.home.html)) for *CEN/FT*-like genes identified six additional members (Appendix E). We named these genes *PtCENL-2*, *PtCENL-3*, and *P. trichocarpa* *FT*-like -1 to -4 (*PtFTL-1* to *PtFTL-4*). All encoded deduced proteins of either 173 or 174 amino acid residues. A phylogenetic analysis indicates a small CEN/FT-like protein family exists within the poplar genome, with possibly two clusters (Figure 3C). *PtCENL-1* to -3 formed one cluster; *PtCENL-1* was more closely related to *PtCENL-2* (91%) than to *PtCENL-3* (70%). *PtFTL-1*

to -4 formed another cluster at the opposite end of the tree with 80% and 76% homology to *OsHD3a* and *AtFT*, respectively, while *PtMFT* was independent of either group. *PtFTL*-1, -3 and -4 grouped together and shared 90% identity with *PtFTL*-2. Poplar FT-like proteins were more similar to *PtCENL*-1 (59%) than to *PtMFT* (49%).

### ***PtCENL-1* and *PtMFT* are differentially expressed**

Real-time reverse transcription PCR (RT-PCR) was conducted to determine *PtCENL-1* and *PtMFT* RNA levels in different tissues. Primers that were specific to each gene and spanning the introns were used in PCR. *PtCENL-1* expression was detected at varying levels in all tissues tested (Figure 4A, Appendix F). On the relative expression scale, the highest level was detected in newly-formed vegetative buds ( $1,641 \pm 430$ ), followed by shoot apices ( $926 \pm 9$ ). The lowest level was detected in already expanded leaves ( $2.7 \pm 1.5$ ). *PtCENL-1* expression was detectable by RT-PCR at very low levels in the vascular tissues, seedlings and floral tissues (relative expression  $<20$ ) (Figure 4A and Figure 4B). *PtCENL-1* mRNA level in actively growing vegetative tissues was approximately 300-fold above that of floral tissues. These results indicate that *PtCENL-1* activities were concentrated in actively differentiating vegetative meristems, rather than in floral meristems.

In comparison to *PtCENL-1*, *PtMFT* expression was more subtle – transcript levels were generally low in all tested tissues, with only 80-fold difference between the highest and the lowest level (compared to over 1000-fold for *PtCENL-1*), and transcripts were not detected in xylem and phloem (Figure 4A and Figure 4B). However, of all the floral tissues examined, *PtMFT* transcripts were detected at least 10-fold higher in inflorescence buds when compared to expanded flowers (Figure 4B), suggesting a role early in floral bud development.

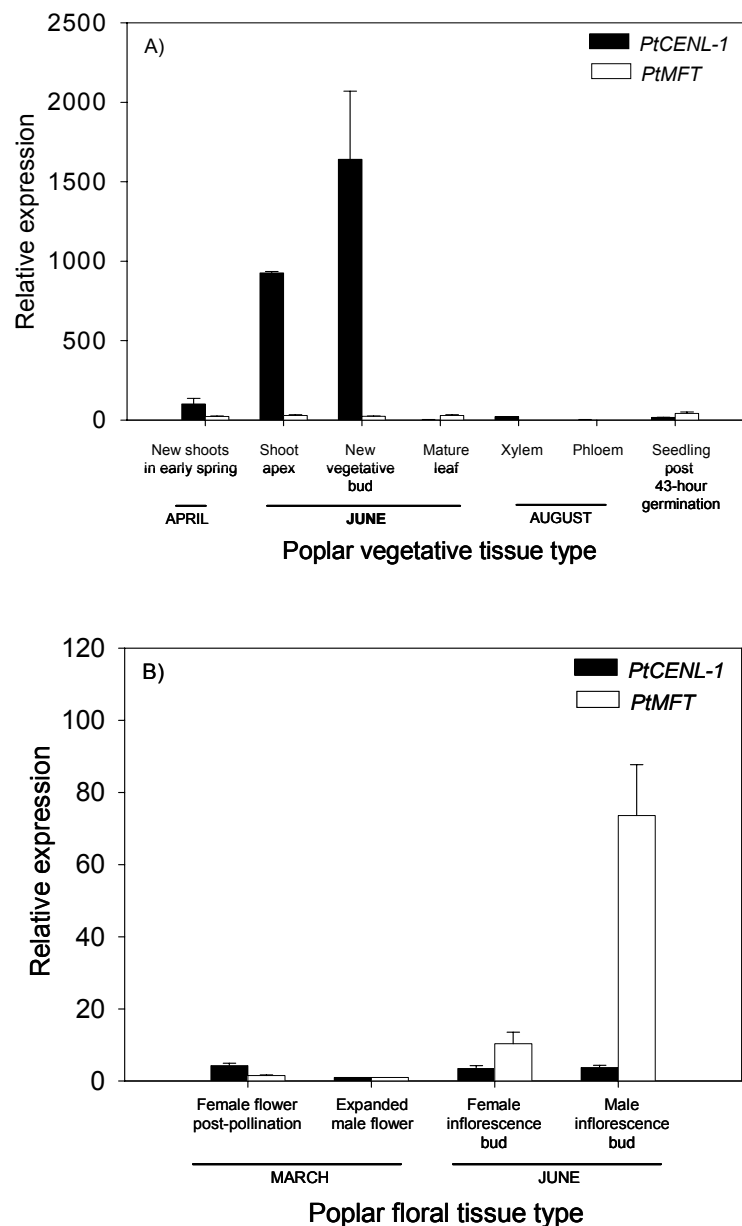
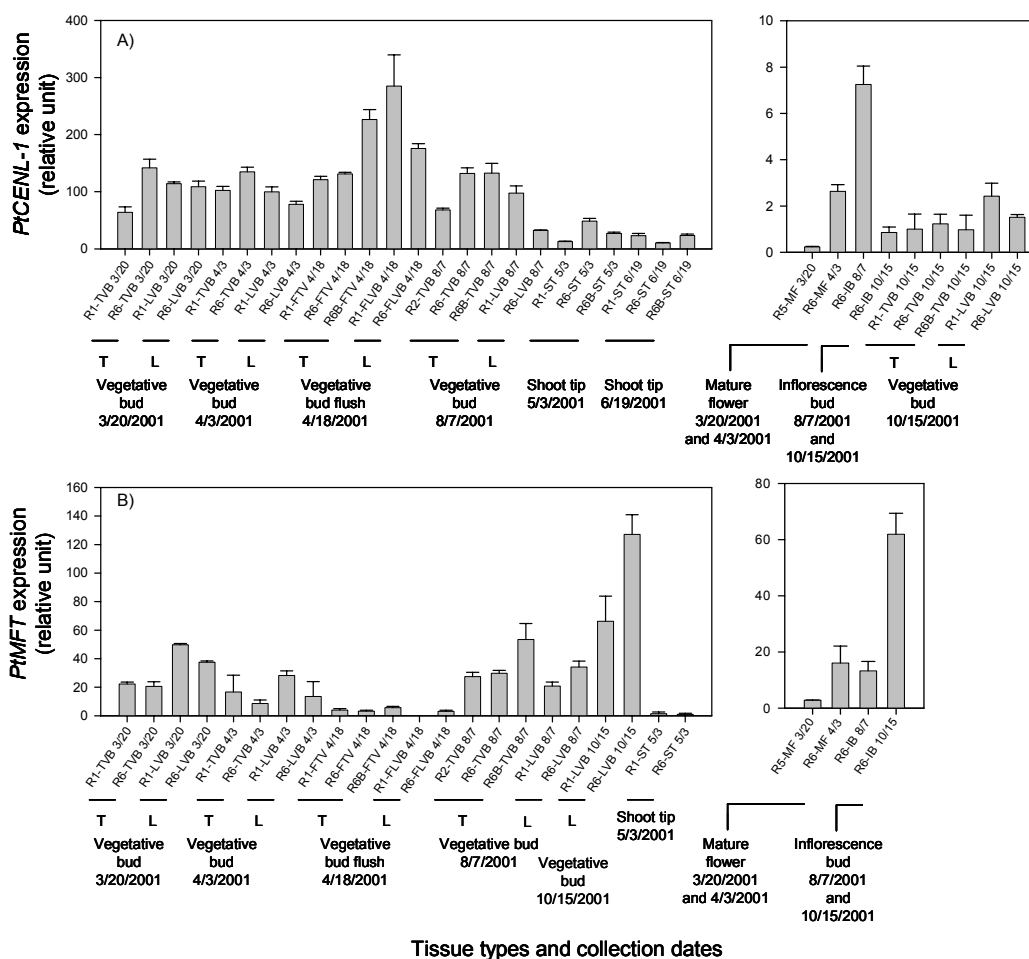

**Figure 4** *PtCENL-1* and *PtMFT* mRNA levels in vegetative (A) and floral organs (B) detected by real-time RT-PCR. The months during which tissues were collected are indicated below tissue description. A total of 1  $\mu$ g of total RNA was used in reverse transcription. Transcript quantities were determined by SYBR-green detection method and reported as relative expression. Ct values were calibrated to a specific sample with the highest Ct (lowest expression) and normalized to *UBQ* to control for loading errors. Bars are standard deviations over two real-time PCR runs using the same cDNA templates, with duplicate PCR reactions in each run.

### ***PtCENL-1* and *PtMFT* expression have contrasting seasonal patterns**

To relate the expression pattern of *PtCENL-1* and *PtMFT* with seasonal changes, we examined their mRNA levels in a variety of poplar tissues sampled from trees growing in the field throughout the course of one flowering cycle. We determined transcript levels via RT-PCR using gene-specific primers. We found *PtCENL-1* to be expressed in a seasonal- and tissue-dependent pattern; similar patterns were seen in both juvenile (R1 or R2) and mature trees (R5 or R6) (Figure 5A, Appendix F). *PtCENL-1* expression was strong in both terminal and lateral vegetative buds (TVB/LVB expression ranged from 64 to 142) from post-dormancy through early spring (March 20 and April 3), and peaked when the buds flushed (R1/R6-FTV =  $121 \pm 6$  /  $131 \pm 3$  and R1/R6-FLVB =  $285 \pm 55$  /  $176 \pm 8$ , respectively). Expression in FLVB was almost two-fold higher than observed in FTV. Expression levels dropped drastically in new shoot tips growing in May and June (ST expression levels ranged from 10 to  $< 50$ ), but increased again in new TVB and LVB in August (ranged from 32 to 132). However, *PtCENL-1* expression dropped to the lowest in fall ( $< 3$  in October), when the buds were entering endodormancy (Lang, 1987: dormancy response within bud in response to changing temperature/photoperiod). Other than the exceptionally low expression in the dormant buds, we observed relatively high expression of *PtCENL-1* in all other vegetative buds. *PtCENL-1* expression in mature inflorescence tissues and inflorescence buds (MF and IB) was as low as in the dormant vegetative buds, except for the inflorescence buds formed in August (R6-IB =  $7 \pm 1$ ).

Generally, levels of *PtMFT* expression were lower than that of *PtCENL-1* (note scales in Figure 5A vs. Figure 5B). In contrast to *PtCENL-1*, *PtMFT* expression was induced when vegetative buds progressed into dormancy (R1/R6-LVB =  $66 \pm 18$  /  $127 \pm 14$ ) and its expression was suppressed when the buds flushed in April (FTV and FLVB expression levels  $< 6$ ), and was barely detected in shoot tips. Transcript levels in vegetative buds collected on March 20 (post-



**Figure 5** *PtCENL-1* (A) and *PtMFT* (B) mRNA levels in a variety of poplar tissues sampled across a seasonal cycle, detected by real-time RT-PCR. Plant tissues were collected from juvenile (R1 and R2) and adult trees (R5 and R6) of a hybrid poplar (*Populus trichocarpa* x *P. deltoides*, clone 15-29) in March, April, August and October of 2001, which corresponded to post-dormancy, spring, summer and fall, respectively. Transcript quantities were determined from 1  $\mu$ g of total RNA extracted from 0.2 g plant tissue, using SYBR-green detection method in RT-PCR and reported as relative expression. Ct values were calibrated to a specific sample with the highest Ct (lowest expression), and normalized to *UBQ* to control for loading errors. Bars are standard deviations over two wells in a single real-time PCR run. TVB and LVB = terminal and lateral vegetative buds, respectively; FTV and FLVB = terminal and lateral vegetative budflush, respectively; ST = shoot tips; MF = mature flower; and IB = inflorescence bud. All samples were collected from the upper crowns, excluding R6B, which were taken from the basal/lower crowns.

dormancy), April 3 (early spring, prior to flushing), and August 7 (new buds in summer) had no obvious differences. *PtMFT* expression levels in all floral tissues were comparable to that of vegetative tissues. Interestingly, however, *PtMFT* was detected at a high level in inflorescence buds in early fall (IB =  $62 \pm 8$ ), a level that was as high as that seen in dormant vegetative buds.

These results indicate that *PtCENL-1* and *PtMFT* were expressed in all tissue types, both vegetative and floral; however, at varying levels depending on the specific tissue's developmental stage during a season. Patterns of expression differed between the two genes. Activity of the *PtCENL-1* gene was dominant in actively differentiating vegetative buds; while *PtMFT* expression was more of a background level in all tissue types and prevalent in dormant buds.

## DISCUSSION

We have cloned two *TFL1*-like genes, *PtCENL-1* and *PtMFT*, from poplar. The structure of the two genes is highly conserved – each contains four exons and three introns of variable lengths with conserved splicing sites, identical to those in other known *TFL1* homologs (Bradley et al., 1996; Jensen et al., 2001). Both genes encode 19-kD proteins; however, each being similar in identity to different TFL1 members of antagonistic functions. Comparisons with other TFL1 family members showed that *PtCENL-1* groups with CEN proteins from tobacco, *Antirrhinum*, and from rice, a monocot species. *PtCENL-1* encodes a protein similar to *AmCEN* (77%) and *AtTFL1* (72%), which are responsible for maintaining *Antirrhinum* and *Arabidopsis* plants, respectively, in an indeterminate inflorescence phase (Bradley et al., 1996; Ratcliffe et al., 1998).

*PtMFT* encodes a protein with high homology to *AtMFT* (78%). The next closest relatives are rice *OsTFL1* (63%) and tomato *LeSP2G* (57%), but both were closer to TFL1. In fact, poplar *PtMFT* is closer in protein identity to *AtCEN* (54%) rather than to proteins of the other four PEBP members of *Arabidopsis*: *AtTFL1*

(50%), *AtBFT* (49%), *AtTSF* (48%), and *AtFT* (45%) (Figure 3C, Appendix D). This places *PtMFT* with *AtMFT* in a group different from CEN and FT. Another factor that grouped these two proteins together is a tryptophan (W) residue at position -83 (Figure 3B). This position is one of the six locations determined by crystallography as a highly conserved ligand-binding site in *AmCEN* (Banfield and Brady, 2000). Identity of a single key residue at the respective position defines protein effects as either TFL1-like (histidine-H) or FT-like (tyrosine-Y). There is a weak FT-like effect in the case of W (Hanzawa et al., 2005). Because *PtMFT* and *AtMFT* both have W at this position, we predict that *PtMFT* has a weak FT-like effect, similar to that shown by *AtMFT* in *Arabidopsis* (Yoo et al., 2004). *PtCENL-1* has the amino acid H; therefore, it may have an effect similar to TFL1/CEN. Among the plant proteins having an H residue are *LeSP*, *LpTFL1*, *CsTFL*, and *MdTFL1*, all of which are functionally similar to *Arabidopsis* TFL1/CEN (Pnueli et al., 1998; Jensen et al., 2001; Pillitteri et al., 2004; Kotoda and Wada, 2005).

We studied *PtCENL-1* and *PtMFT* expression using real-time reverse transcription (RT-PCR). Because RT-PCR is highly sensitive to variation in template quantity and quality, and because we tested gene expression in a variety of tissues, we employed a reference gene. To choose a gene useful for similar studies in poplar, Brunner et al. (2004b), tested the expression of 10 poplar housekeeping genes in eight kinds of tissues, including floral and vegetative buds collected during different seasons. Among the 10 genes studied, polyubiquitin (*UBQ*) was the most stably expressed gene. It had a very low coefficient of variation (CV: 3.4%), based on mean Ct values among all tested tissues (Brunner et al., 2004b). Similarly, in our own study using over 30 different tissue types (Figure 4 and Figure 5; Appendix G), we found very low CV values for *UBQ* (< 5 %).

Our expression data suggest that *PtCENL-1* is expressed preferentially in vegetative buds and shoot apices that are actively differentiating during the growing season, although its transcripts were also detected in all examined vegetative, floral, and vascular tissues (Figure 4A and Figure 4B). *CEN* and *CET1*

messages have also been detected from tissues other than shoot meristematic regions in *Antirrhinum* and tobacco, respectively (Bradley et al., 1996; Amaya et al., 1999). Tomato *SP* is expressed in all primordia throughout development (Pnueli et al., 1998). In ryegrass, the *TFLI*-like gene is found in all developmental stages from germination to maturity (Jensen et al., 2001). However, in citrus trees, *CsTFLI* was not detected in seeds and the adult vegetative tissues, including root, stem and leaf, although they are present in all four floral organs (Pillitteri et al., 2004). Apple *MdTFLI* (GenBank, BAD06418) has been detected in various vegetative tissues, excluding mature leaves (Kotoda and Wada, 2005), similar to *PtCENL-1*. However, it has not been detected in floral organs. *PtCENL-1* shared 78% and 79% identity with *CsTFL* protein from the woody perennial citrus and *MdTFL1* from apple, respectively.

Our seasonal expression studies showed that *PtCENL-1* mRNA was strongly expressed in post-dormancy buds in spring, peaked in emerging shoots during budburst, but weakened in elongated shoots. *PtCENL-1* mRNA was found suppressed in buds entering dormancy in fall but was upregulated in spring buds. This is consistent with ryegrass *LpTFLI* expression, which is suppressed in vernalized plants but is upregulated upon exposure to warmer conditions and long photoperiods (Jenson et al., 2001). These results indicate that *PtCENL-1* is possibly involved in maintaining the juvenile state of post-dormancy vegetative meristems. Whether or not it plays a role in maintaining the juvenile phase in poplar is yet to be ascertained. Citrus *CsTFL* and apple *MdTFLI* appear to be involved in the maintenance of the vegetative phase, based on their effects during overexpression in *Arabidopsis* (Pillitteri et al., 2004; Kotoda and Wada, 2005).

We found that *PtMFT* was expressed in both vegetative and floral tissues at relatively low levels, but was absent from vascular tissues. *PtMFT* was also expressed preferentially in inflorescence buds. In tomato, *MFT* homolog is expressed in all tested organs and developmental stages (Carmel-Goren et al., 2003). These include vegetative tissues, floral organs, cotyledons, and immature fruit. *Arabidopsis MFT*, the closest homolog in amino acid identity to *PtMFT*, is

also expressed constitutively in the tested tomato organs (Carmel-Goren et al., 2003). *MFT* functions as a floral inducer in *Arabidopsis* (Yoo et al., 2004). We studied *PtMFT* transcript levels in various tissues during different times of the year. Its expression level was remarkably low in flushing buds when compared to any of the post-dormancy buds (March and early April). Interestingly, *PtMFT* levels were elevated in both dormant vegetative and floral buds. Its activity is photoperiod-dependent; it is upregulated under short days, and is suppressed under long days when the climate gets warmer and when growth resumes. These suggest a role for *PtMFT* in onset of bud dormancy.

To further elucidate each gene's function, we have undertaken transgenic studies (Chapter 3). We report several transgenic poplar events that carry an RNA interference (RNAi) construct for suppressing endogenous *PtCENL-1*, flowered early when grown under field conditions. When assessing *PtMFT* in wild-type *Arabidopsis* using the 35S construct, we found functional similarity to *AtMFT* at inducing early flowering. These results further support our hypothesis that *PtCENL-1* acts similarly to *CEN* in *Antirrhinum*, to prolong the vegetative phase, and that *PtMFT* acts similarly to *AtMFT* in *Arabidopsis*, to promote early flowering.

### **Chapter 3: SUPPRESSION OF *PtCENL-1*, A *POPULUS* HOMOLOG OF *CENTRORADIALIS*/*TERMINAL FLOWER 1*, INDUCES EARLY FLOWERING IN FIELD-GROWN TRANSGENIC POPLAR**

#### **ABSTRACT**

To study the mechanisms that control onset of flowering in trees, we cloned two *Populus trichocarpa* homologs of the *Arabidopsis* *TERMINAL FLOWER 1* (*TFL1*) gene. Members of the *TFL1* gene family both advance and delay onset of flowering in *Arabidopsis*. We studied *PtCENL-1* and *PtMFT*, the poplar homologs of *CENTRORADIALIS* (*CEN*) and *MOTHER OF FT AND TFL1* (*MFT*) genes, respectively. We field-tested transgenic poplars that overexpressed and had RNAi-mediated reduced expression, of both genes. Suppression of native *PtCENL-1*, to less than half its normal expression level in shoots, induced flower formation in juvenile transgenic trees growing under natural, long photoperiods. Overexpression of the *PtCENL-1* transgene caused delayed shoot emergence after winter dormancy (bud flushing). These results suggest that *PtCENL-1* helps to postpone flowering and prolongs bud dormancy in poplar trees. In contrast, overexpression and suppression of *PtMFT* did not give a detectable change in flowering, phenology, or growth rate of field-grown poplars, though it did affect time of flowering in *Arabidopsis*. We conclude that *PtCENL-1*, but not *PtMFT*, could accelerate and perhaps delay flowering, and modify the timing of post-dormancy bud flushing in poplar.

#### **INTRODUCTION**

Plant species and varieties flower at very different ages, indicating that flowering is strongly controlled by internal developmental factors. By reaching a certain age and perhaps size, the adult vegetative meristems become competent to

respond to floral induction, often by means of environmental stimuli such as photoperiod, temperature, and nutrients (Bernier et al., 1993; Yanovsky and Kay, 2003). Genetic and molecular studies in model plant species such as *Arabidopsis* and *Antirrhinum* have revealed the activities of many genes in the regulatory network that control reproductive phase transition. There are four major genetic pathways that control flowering time in *Arabidopsis* (reviewed in Simpson et al., 1999). In the photoperiod promotion pathway, photoreceptors in plants perceive light from long days, and together with an endogenous circadian clock, integrate the signals to promote flowering. In the vernalization pathway, long exposure to cold treatment induces flowering. In the autonomous pathway, no external cues are needed; plants respond to endogenous cues to flower. Lastly, the gibberellic acid (GA) pathway promotes flowering mediated by GA signaling.

Two key genes that control flowering onset are *TERMINAL FLOWER 1* (*TFL1*) and *FLOWERING LOCUS T* (*FT*). *TFL1* in *Arabidopsis* (Bradley et al., 1997), its functional homolog *CENTRORADIALIS* (*CEN*) in *Antirrhinum* (Bradley et al., 1996) and *CET* in tobacco (*CEN* homolog) (Amaya et al., 1999), have been identified as a group of genes that control inflorescence architecture and length of the vegetative phase. Overexpression of *TFL1* in *Arabidopsis* greatly extends both vegetative and reproductive phases, resulting in larger plants with heavily branched inflorescences (Ratcliffe et al., 1998). *TFL1* and *CET* are also floral repressors in *Arabidopsis* and tobacco, respectively. Similar phenotypes to those observed in 35S::*TFL1* transgenic *Arabidopsis* were also seen in *Arabidopsis* when *TFL1*-like genes from other plant species were ectopically expressed. These include homologs from ryegrass (Jensen et al., 2001); rice (Nakagawa et al., 2002); citrus (Pillitteri et al., 2004); and apple (Kotoda and Wada, 2005).

*TFL1* and *CEN* belong to the family of the mammalian phosphatidylethanolamine-binding proteins (PEBPs). They are kinases that regulate signaling pathways (Yeung et al., 1999; Banfield and Brady, 2000). There are six genes encoding PEBPs in the *Arabidopsis* genome, including *FT*. *TFL1* and *FT* encode proteins with opposing effects in *Arabidopsis* (Kardailsky et al., 1999).

*FT* is a floral promoter that takes part in the photoperiodic pathway (Kardailsky et al., 1999; Kobayashi et al., 1999). Overexpression of another member, *TWIN SISTER OF FT (TSF)*, promotes early flowering, while overexpression of yet another member, *Arabidopsis* version of *CEN (ATC)*, shows the opposite effect (Kobayashi et al., 1999; Mimida et al., 2001). *TSF* and *FT* share similar modes of regulation under long photoperiods, suggesting some redundancy in their functions in promoting flowering (Yamaguchi et al., 2005). *FT* transcripts are expressed in leaves, but can travel through the vascular system to the shoot apex and interact with a bZIP transcription factor, *FD*, to activate floral identity genes such as *APETALAI (API)* and promote flowering under long days (Abe et al., 2005; Huang et al., 2005; Wigge et al., 2005). *MOTHER OF FT AND TFL1 (MFT)* is one member of the PEBPs in *Arabidopsis*, whose function remains poorly defined. Overexpression of *MFT* leads to early flowering in *Arabidopsis*; however, an *mft* mutant had normal flowering time (Yoo et al., 2004). This suggests that *MFT* functions as a floral inducer but acts redundantly with *FT* in *Arabidopsis* (Yoo et al., 2004).

We isolated and characterized the expression of two *TFL1* homologs, *P. trichocarpa CENTRORADIALIS LIKE-1 (PtCENL-1)* and *P. trichocarpa MOTHER OF FT AND TFL1 (PtMFT)* from poplar (Chapter 2). *PtCENL-1* and *PtMFT* show contrasting patterns of expression; the former is expressed at high levels in vegetative buds during growing season, while the latter is expressed at high levels in the inflorescence buds in fall. Because *PtCENL-1* protein sequence shares high similarity to that of *CEN* (77%) and *PtMFT* is 78% similar to *MFT*, we speculate their functions to be similar to that of *TFL1/CEN* and *MFT* proteins, respectively. In the present work, we analyzed the functions of the two genes by overexpressing and suppressing them in transgenic poplar. The transgenic trees were planted in the field to expose them to natural conditions and their growth and reproduction studied over two years. We report that *PtCENL-1* suppression accelerates flowering, while its overexpression delays timing of vegetative budflush.

## MATERIALS AND METHODS

### Plasmid construction

*PtCENL-1* and *PtMFT* DNA fragments were amplified by PCR using gene-specific primers from a male floral cDNA template of a wild *P. trichocarpa* collected near Corvallis, Oregon, USA. To create the overexpression constructs, the complete coding sequence of *PtCENL-1* (GenBank, AY383600) and *PtMFT* (GenBank, DQ310725) were amplified using specific primers. The primers for *PtCENL-1* were 5'-CGAAGCTTATGGCAAAGATGTCA-3' and 5'-TCGAGCTCTTATCTTCTCCTCAACGT-3', with *Hind* III and *Sst* I sites (underlined) introduced at the 5' and 3' ends, respectively. The primers for *PtMFT* were 5'-CTGGATCCATGGCTGCCTCTGTTGA-3' and 5'-CGGAGCTCTTAGCGCCTCTTATTTGCTG-3', with *Bam*HI and *Sst* I sites (underlined) introduced at the 5' and 3' ends, respectively. The amplified products were then introduced into the region between 35S promoter and terminator of the cauliflower mosaic virus (CaMV) 35S cassette given by Dr. Roger Hellens, John Innes Centre, UK ([http://www.pgreen.ac.uk/a\\_cst\\_fr.htm](http://www.pgreen.ac.uk/a_cst_fr.htm)) (Appendix H). The entire cassettes, 35S<sub>pro</sub>::*PtCENL-1*::35S<sub>ter</sub> and 35S<sub>pro</sub>::*PtMFT*::35S<sub>ter</sub> were then excised from the plasmids by *Eco*R V and ligated into the filled-recessed termini of *Sst* I site of the binary vector pART27 (Gleave, 1992), given by Dr. Andrew Groover, USDA Forest Service, Davis, CA, USA, resulting in pA35SPCENL-1 and pA35SPMFT, respectively. The binary vectors had a kanamycin resistance gene (*NPTII*) for in vitro selection.

The suppression vector for creating RNA interference (RNAi) constructs, pHANNIBAL (Wesley et al., 2001), was given by Dr. Peter Waterhouse, CSIRO Plant Industry, Canberra, Australia. Expression of the vector was driven by CaMV 35S promoter and octopine synthase (OCS) terminator, with an intron, pyruvate orthophosphate dikinase (PDK), intermediate. For *PtCENL-1* suppression, a 147 bp fragment from the 3' end of the *PtCENL-1* coding sequence was amplified using

primers 5'-GACTCGAGAAGGCAAACAGTGACC-3' and 5'-GTGGTACCTTATCTTCTCCTCAACGTT-3', with *Xho* I and *Kpn* I sites (underlined) introduced at the 5' and 3' ends, respectively, and then fused into the 5' end of the *PDK* intron (left arm). The same fragment was again amplified using primers 5'-GCTCTAGAAAGGCAAACAGTGACC-3' and 5'-GTATCGATTTATCTTCTCCTCAACGTT-3' to introduce *Xba* I and *Cla* I sites (underlined), for directional anti-sense orientation of the fragment into the 3' end of the *PDK* intron (right arm). For *PtMFT* suppression, a 239 bp fragment from the 5' region of the *PtMFT* coding sequence was used instead. The sense fragment was fused to the left arm at the *EcoR* I and *Kpn* I sites (underlined) using primers 5'-GTGAATTCATGGCTGCCTCTGTTGATC-3' and 5'-GTGGTACCATTCTGGGTTCACTAGGGCT-3', while the anti-sense arm was fused to the left arm at the *Xba* I and *Cla* I sites (underlined) using primers 5'-GTTCTAGAATGGCTGCCTCTGTTGATC-3' and 5'-GTATCGATATTCTGGGTTCACTAGGGCT-3'. The resulting cassettes were released from their respective RNAi plasmids by *Not* I digestion and then ligated into pART27, generating pAHAN-PCENL-1 and pAHAN-PMFT (Appendix H).

### ***Arabidopsis* transformation and evaluation of transgenic plants**

*Arabidopsis thaliana* (ecotype Columbia) plants were transformed with *Agrobacterium tumefaciens* strain GV3101 harboring pA35SPCENL-1 or pA35SPMFT (for *PtCENL-1* and *PtMFT* overexpression, respectively), following the floral dip method (Clough and Bent, 1998). Transformed seeds were placed on agar plates containing Murashige-Skoog medium (1/2 strength) and 25 mg/L of kanamycin. The seeds were allowed to germinate for 10 to 12 days before being transplanted into soil. Wild-type plants were germinated on the same medium lacking kanamycin. Plants were grown in a growth chamber at 22 °C under a 16 hr photoperiod. Different light sources were used in the growth chamber to induce

phenotypes. For growing 35S::*PtMFT Arabidopsis*, light was provided by fluorescent tubes (F40PL/AQ, General Electric; and F20T12/CW, Philips) at a photon flux density of 30 to 40  $\mu\text{Em}^{-2}\text{s}^{-1}$ . Whereas, for growing 35S::*PtCENL-1 Arabidopsis*, light was provided by fluorescent tubes (TL70 F32T8/TL741, Philips) and incandescent light bulbs (60 watt, Soft White, General Electric), at a photon flux density of 50 to 60  $\mu\text{Em}^{-2}\text{s}^{-1}$ . Date of bolting was counted when the primary inflorescence reached 1 cm above soil. For RNA extraction, cauline leaves and stems were collected when the plants started to form siliques. Tissue samples were flushed in liquid nitrogen and stored at  $-80\text{ }^{\circ}\text{C}$  until further use.

### **Poplar transformation and transgene confirmation**

Poplars from hybrid 717-1B4 (*P. tremula* x *P. alba*, INRA France) were transformed with *A. tumefaciens* strain GV3101 harboring pA35SPCENL-1 and pA35SPMFT (for *PtCENL-1* and *PtMFT* overexpression, respectively), and pAHAN-PCENL-1 or pAHAN-PMFT (for *PtCENL-1* and *PtMFT* suppression, respectively) following an established *Agrobacterium*-mediated transformation protocol (Filichkin et al., in press). Transformed plants were selected based on their rooting ability in kanamycin (25 mg/L) and further verified via PCR analysis (Appendix I). For detection of overexpression cassettes in the transgenics, the region between the promoter and the terminator of 35S was amplified using the primers: 5'-GCACAATCCCCTATCCTTC-3' and 5'-AGATTTGTAGAGAGAGACTGGTGA-3', which gave rise to product sizes of 698 bp (*PtCENL-1*) and 684 bp (*PtMFT*). For detection of RNAi cassettes in the transgenics, two sets of primers were designed. The first set, 5'-TTCCAACCACGTCTTCAAAG-3' and 5'-CTTCTTCGTCTTACACATCACTTG-3', amplified the left arm region between the 35S promoter and the PDK intron (product sizes: 500 bp for *PtCENL-1* and 592 bp for *PtMFT*). The second set,

5'-AGTCGAACATGAATAACAAGGT-3' and 5'-GTAAGGATCTGAGCTACACATGC-3', amplified the right arm region between the PDK intron and the OCS terminator (product sizes: 394 bp for *PtCENL-1* and 486 bp for *PtMFT*). PCR was performed on genomic DNA isolated from plants grown in tissue culture following a small-scale DNA extraction protocol developed specifically for poplar (<http://zircote.forestry.oregonstate.edu/tgbb/protocols/dnaext.htm>, Appendix J).

### **Field performance and phenotypic assessment**

Young in vitro-grown plants, about two months old, were potted in soil and grown in the greenhouse for another two months before being planted in the field for growth performance and phenotypic observation. Together with a non-transgenic control, the transgenic poplars were planted at a field site near Corvallis, Oregon, USA, in June 2003. Four ramets from individual transgenic events were transplanted in two pairs with each pair being placed randomly on the site. For growth assessment, height and diameter were measured in early spring 2004, and again in fall 2004. Tree volume index (VI) was calculated as height  $\times$  diameter<sup>2</sup> (cm<sup>3</sup>) and data were transformed to natural logarithm (ln) to better approximate normality. Net growth was defined as the difference between ln(VI) at the beginning (VI1) and ln(VI) at the end of the measurement period (VI2).

The timing of post-dormancy vegetative budflush was recorded on field-grown trees in spring 2005. The occurrence of budflush was recorded when any buds along the main stem began to open. The day when the first bud flushed was recorded in Julian. Data were also transformed into natural logarithmic (ln) values.

Tree volume index (VI), calculated as described above, and the date of budflush, were analyzed in SAS (version 9.1, SAS Institute Inc., 2002-2003) using the MIXED procedures to test effects from constructs, and events within constructs. The statistical model treats constructs as fixed factors, and events within constructs

as random factors. The response (Y-data) is the average of the two ramets in a pair, resulting in two independent data points for each transgenic event, and five data points for the control trees. To estimate and test differences between means, we used the LSMEANS statement in SAS program. Tukey-Kramer's adjustment was used for all possible pair-wise comparisons between transgenic group means; and Dunnett's adjustment was employed for comparisons between transgenic events and non-transgenic controls.

### **RNA extraction and real-time RT-PCR**

Poplar cuttings were taken from branches of two dormant ramets for each transgenic event from the field in April 2005 and forced to flush in the greenhouse. Newly flushed small leaflets (approximately 1 to 2 cm), including shoot meristems, were pooled from each ramet, dropped into liquid nitrogen and stored at -80 °C. Total RNA was extracted from 0.2 g of plant material using a modified protocol <http://zircote.forestry.oregonstate.edu/tgbb/protocols/PoplarRNAextraction.pdf>, Appendix B) combined with the RNeasy Mini Kit (Qiagen, Valencia, CA, USA), and then treated with the DNA-free Kit (Ambion, Austin, TX, USA) to remove DNA. RNA from *Arabidopsis* samples were extracted from 0.02 g of plant material using the RNeasy Mini Kit.

A total of 1 µg of treated RNA was reverse-transcribed in vitro using SuperScript™ First-Strand Synthesis System for RT-PCR (Invitrogen, Carlsbad, CA, USA) following the manufacturer's instructions. The cDNA mixtures were then diluted five-fold and used directly in real-time RT-PCR. For *Arabidopsis* samples, 0.2 µg of treated RNA was used in cDNA synthesis and then diluted five-fold for RT-PCR. To establish a standard curve for RT-PCR efficiency determination, cDNA from a sample identified in preliminary real-time PCR reactions as having high levels of the target gene transcripts, was diluted serially

five to six times in five-fold increments. The diluted cDNAs were used as standard templates and run together with unknowns in each real-time PCR plate.

RT-PCR was carried out to detect *PtCENL-1* and *PtMFT* transcripts in transgenic poplars. Gene-specific primers were designed using the Primer 3 software available at [http://frodo.wi.mit.edu/cgi-bin/primer3/primer3\\_www.cgi](http://frodo.wi.mit.edu/cgi-bin/primer3/primer3_www.cgi) (Rozen and Skaletsky, 2000). Forward primers for overexpression constructs were 5'-AGCCGCTGTCTTCTTCAATG-3' (*PtCENL-1* overexpression) and 5' TGCCACCGTCTACTTCAATGC-3' (*PtMFT* overexpression). Both primers, when coupled with a reverse primer specific to the 35S terminator, 5'-AAGAACCCTAATTTCCCTTATCG-3', amplified PCR products of 177 bp and 166 bp, respectively. The same primer sets were employed to detect both transgenes in transformed *Arabidopsis* plants. Forward and reverse primers for the detection of endogenous *PtCENL-1* were: 5'-CCTTTTTCACCCCTGGTCATGA-3' and 5'-CAGTGTAGGTGCTCCCTGAGGTA-3'. Forward and reverse primers for detecting endogenous *PtMFT* were: 5'-CGAGGGAAAGAGATCCTTTCCT-3' and 5'-AAAGCACCAGTATGTAGCGATGAA-3'. Forward and reverse primers for detecting the poplar housekeeping gene, polyubiquitin (*UBQ*), were: 5'-TGTACTCTTTTGAAGTTGGTGT-3' and 5'-TCCAATGGAACGGCCATTAA-3'. The resulting product sizes were 76, 73, and 75 bp, respectively. Forward and reverse primers for detecting the *Arabidopsis* housekeeping gene, *UBQ*, were: 5'-GTTCAATGTTTCGTTTCATG-3' and 5'-TAACAGGAACGGAAACATAG-3', yielding a product size of 100 bp.

RT-PCR was performed in a 25- $\mu$ l final volume composed of 12.5  $\mu$ l of Platinum<sup>®</sup> SYBR<sup>®</sup> Green qPCR SuperMix-UDG (Invitrogen, Carlsbad, CA, USA); 0.4  $\mu$ M each of forward and reverse primer; and 1  $\mu$ l of the cDNA reaction mixture as template. Reactions were setup in 96-well plates and run on a MX3000P<sup>™</sup> RT-PCR System (Stratagene, La Jolla, CA, USA). All plates contained duplicate PCR reactions per cDNA sample, and triplicate PCR reactions per serially diluted standards, for both gene of interest and reference gene. Each real-time PCR experiment was repeated at least twice for each cDNA sample, with duplicate PCR

reactions in each experiment. Reverse transcription was conducted only one time using total RNA extracted from two ramets of each transgenic event.

The threshold cycle (Ct) – the cycle at which product amplification is significantly above background signal – was determined using the MX3000P™ RT-PCR System software (version 2). A control/calibrator sample, usually a sample with the lowest expression or non-transgenic control, was selected for relative quantification. The Ct difference between unknown and control samples ( $\Delta C_{t_{\text{control} - \text{sample}}}$ ) is transformed into relative quantity (RQ), and corrected based on specific gene's RT-PCR efficiency ( $E$ ), using the formula,  $RQ = E^{(\Delta C_{t_{\text{control} - \text{sample}}})}$  (Pfaffl, 2001).  $E$  values are calculated from the slope of the standard curves following Bustin (2000):  $E = 10^{(-1/\text{slope})}$ . To correct for differences in template input across wells, a reference gene was included in all real-time PCR experiments. Normalized relative quantity of the target gene was calculated as  $RQ_{\text{target}}/RQ_{\text{reference}}$ . Normalization, calibration, re-scaling and standard deviation calculations were performed using the qBASE software version 1.2.2 (Hellemans et al., in preparation; <http://medgen.ugent.be/qbase>).

We chose the polyubiquitin (*UBQ*) gene as the internal control because this popular *UBQ* is stably expressed in a variety of different tissues (Brunner et al., 2004b). It had a very low coefficient of variation (CV: 3.4%), based on mean Ct values among all tested tissues (Brunner et al., 2004b). Similarly, in our own study using over 30 different tissue types (Chapter 2; Appendix G), we found very low CV values for *UBQ* (< 5 %).

## RESULTS

### ***PtMFT* promotes and *PtCENL-1* delays flowering in *Arabidopsis***

To help assess the function of the two poplar *TFL1*-like genes, we tested their effects in transgenic *Arabidopsis*. *PtCENL-1* and *PtMFT* cDNAs were expressed

under the control of the 35S promoter and introduced into wild-type (WT) *Arabidopsis* by *Agrobacterium*-mediated transformation. Thirty kanamycin-resistant *Arabidopsis* plants were selected from each transformation event, transferred into soil, and placed in a growth chamber under long days (16 hrs light). The date when the primary inflorescence bolted and reached 1 cm above the soil surface was recorded. Most of the 35S::*PtMFT* plants flowered on days 11 to 20 after transplanting into the soil, while flowering occurred later in WT plants (post 21 d) (Figure 6A). Based on construct means, the 35S::*PtMFT* flowered nine days earlier than WT plants ( $p < 0.0001$ , Student's t test, Appendix K). In other respects, the transgenic 35S::*PtMFT* plants appeared similar to WT plants.

On the other hand, most of the 35S::*PtCENL-1* plants flowered close to the same time as WT plants. However, five of them flowered extremely late or senesced before flowering. We thus classified the 35S::*PtCENL-1* plants into two general groups, flowering and late/non-flowering (Figure 7A). At 40 d, while the WT plants had set seed pods, the extremely delayed flowering events had not yet bolted but they had increased the number of rosette leaves (Figure 7B and Figure 7C). The shoots bolted after 40 d, producing many small cauline leaves along the stems. However, flowers had not yet formed (Figure 7D). At 60 d, the shoot tips formed small leaves arranged in spirals, stacking very close to each other, resulting in a cabbage-like shoot (Figure 7E). The leaves were thick, glossy, succulent and without trichomes. Later in development (after 4 mo), the shoots elongated and the plants grew taller with many axillary shoots and small cauline leaves (Figure 7F). Eventually they formed flowers on the tips, but they were very few and smaller in size compared to WT flowers. Two of the five extreme events never flowered because they senesced. In the flowering group of the 35S::*PtCENL-1* plants, abnormal leaf-like structures were observed on the shoot tips (Figure 7G). One or several shoots elongated from the middle of the abnormal shoot tip, which gave rise to a cluster of flowers or floral buds. This shoot elongation process from within a flower was repeated several times in some cases (Figure 7H). The clustered structures consisted of normal and abnormal flowers or

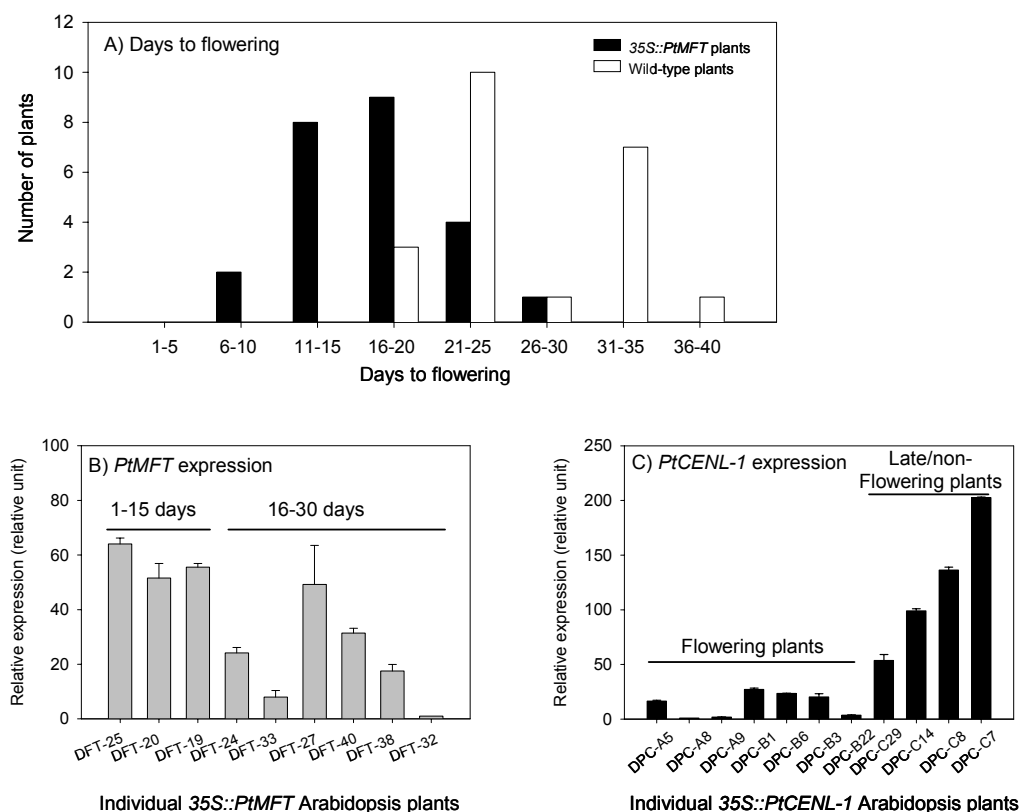

**Figure 6** Timing of flowering and transgene levels in *Arabidopsis* transformants. (A) 35S::PtMFT and wild-type plants after transplanting into soil. (B) Transcript levels of transgene *PtMFT* in selected 35S::PtMFT (DFT) plants grouped according to days to flowering. (C) Transcript levels of transgene *PtCENL-1* in selected 35S::PtCENL-1 (DPC) plants grouped according to flowering or late/non-flowering phenotypes.

floral buds. Flowers with organ abnormalities were detected as well (Figure 7I and Figure 7J). In addition, we also observed the “hallmark” of *TFL1*-like characteristics in the flowering 35S::PtCENL-1 group, whereby axillary shoots were not subtended by cauline leaves (Ratcliffe et al., 1998) (Figure 7A, third plant from left).

In *Arabidopsis*, flowering time correlates with the number of rosette leaves. We counted the number of rosette leaves when we confirmed bolting of primary inflorescences. Based on construct means, the 35S::PtMFT group had four fewer

**Figure 7** Ectopic expression of *PtCENL-1* in wild-type *Arabidopsis*. (A) The flowering and late/non-flowering groups (first plant on the left) of 35S::*PtCENL-1* plants at 30 d after planting. Note the absence of subtending cauline leaves on the upper parts of the third plant from the left. (B) Wild-type Columbia already setting seed pods at 40 d, for comparison. (C) Top view of a representative late flowering 35S::*PtCENL-1* event that has an increased number in rosette leaf, and has not yet bolted at 40 d. (D) Two 35S::*PtCENL-1* transformants with extreme phenotypes at 60 d; already bolted and producing leaf-like structures on the top of the shoots. (E) The cabbage-like shoot top from one extreme 35S::*PtCENL-1* plant, showing compacted leaves that are thick, shiny, and succulent. Trichomes are absent from the leaves. (F) Morphology of three extreme events after 120 d; the main stem elongated and axillary shoots were produced later in development. (G) Leaf-like structures at floral positions on a representative event from the flowering group of 35S::*PtCENL-1* plants. (H) A new shoot emerging from the leaf-like structure (arrow) bearing clusters of floral buds or flowers. (I) and (J) Abnormalities in floral organs observed in some of the 35S::*PtCENL-1* flowering events. Plants were grown in plastic containers with a rim diameter of 5 cm.

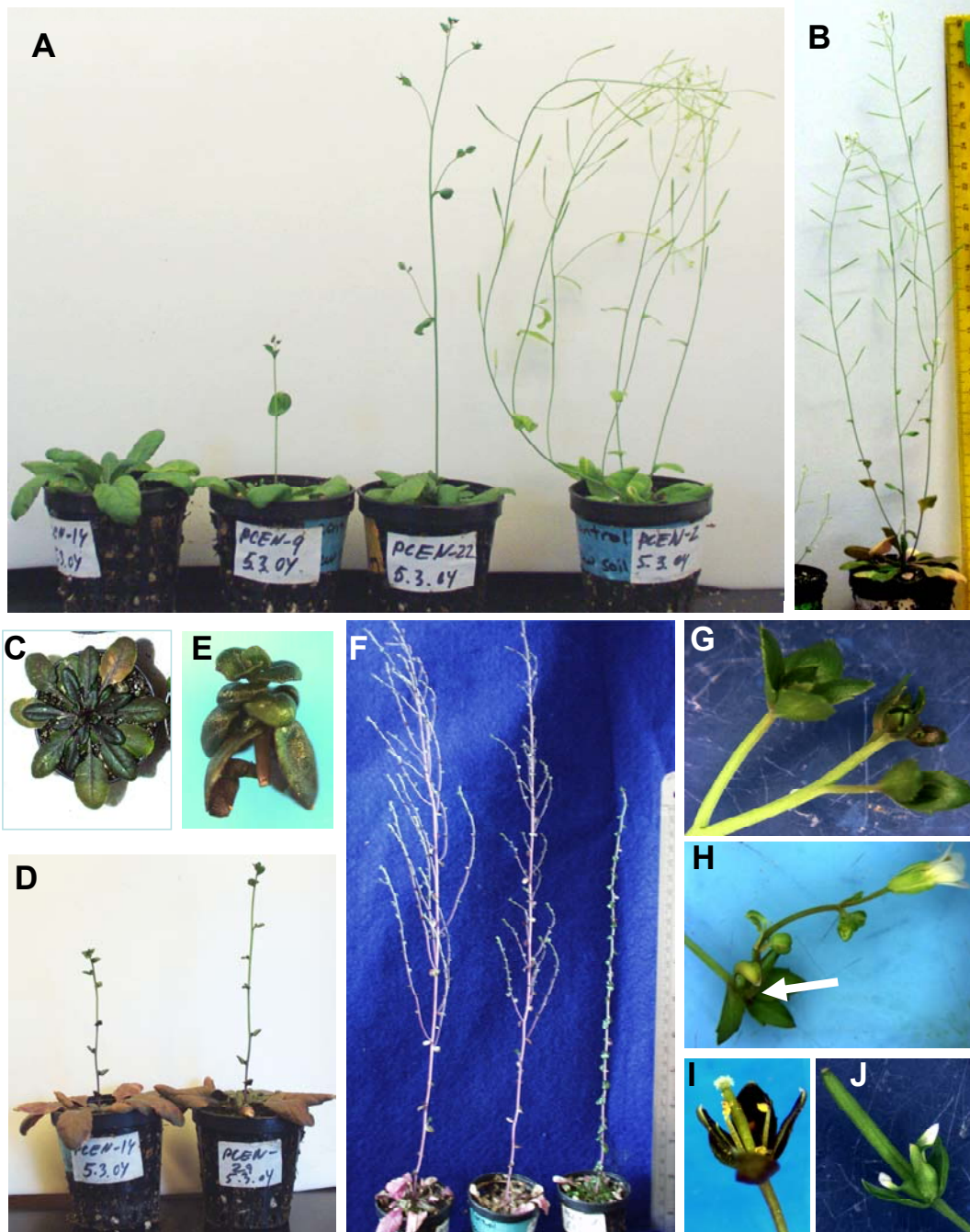

Figure 7

leaves than the WT ( $p < 0.0001$ , Student's *t* test, Appendix K). The severe late flowering 35S::*PtCENL-1* events had between 30 and 50 leaves; two- to five-fold more than the WT plants, which typically has 8 to 12 leaves. Rosette leaf number between the flowering 35S::*PtCENL-1* group and WT was not significantly different (data not shown).

To find the correlation between flowering phenotypes and transgene expression, we determined transcript levels in several representative events from 35S::*PtMFT* and 35S::*PtCENL-1* populations using RT-PCR. On average, the 35S::*PtMFT* plants that flowered very early ( $\leq 15$  days post-transplanting) had transgene RNA levels over two-fold higher than those that flowered later (Figure 6B, Appendix K). Meanwhile, expression levels of transgene *PtCENL-1* in the late/non-flowering *Arabidopsis* transgenics were very high; nine-fold higher than the flowering transgenics of the same construct (Figure 6C, Appendix K).

### **Precocious flowering of silenced *PtCENL-1* transgenic poplars in the field**

The effects of *PtCENL-1* and *PtMFT* on flowering time were tested in poplar hybrid 717-1B4, in the field (Figure 8A). *PtCENL-1* and *PtMFT* were either ectopically expressed under the control of the 35S promoter or their expression suppressed using the RNAi vector, derived from pHANNIBAL. A total of 19 transgenic poplar events were obtained from 19 different calli following transformation with each overexpression vector, while 15 transgenic events were obtained from 15 different calli from each RNAi vector (Appendix L). All of these plants were kanamycin resistant, and their constructs verified via PCR (see Materials and Methods). Ramets (genetically identical trees) of each transgenic poplar event were planted in pairs (a total of four ramets) in the field. The transgenics were similar in growth to that of the non-transgenic controls (see below), regardless of the constructs they were carrying. Interestingly, however, *PtCENL-1* RNAi poplar initiated floral buds during its third growing season in the



**Figure 8** Early-flowering phenotypes of transgenic *Populus tremula* x *P. alba* carrying an RNAi construct for suppressing endogenous *PtCENL-1* expression. (A) Two-year-old transgenic poplars growing in the field. (B) Female flowers borne on upward-pointing shoots on long straight catkins (arrows). (C) Close-up view of a dehiscent catkin with a new vegetative shoot growing on its tip. (D) Floral buds resting in the axils; the upper bud is beginning to expand. (E) A young inflorescence that had flushed a week earlier but failed to develop further. Pictures B to D were taken from transgenic *PtCENL-1* RNAi event 191 on September 5, 2005. Picture E was taken from the same tree two weeks later.

field (end of summer, 2005). Typically, the juvenile phase in poplars lasts for several years and adult trees produced mature flowers/catkins only in spring (Brunner et al., 2004a).

All four ramets belonging to four different transgenic events out of the 15 events produced and tested with the *PtCENL-1* RNAi construct produced floral buds. In two ramets from each of two flowering events, the floral buds flushed, rapidly elongated into mature catkins, thus completing flower development in the same season as they were initiated. This is highly unusual for wild-type poplar hybrid 717-1B4 that are growing in Corvallis, Oregon. Although adult trees set floral buds in August, the buds remain until after winter dormancy before flushing and expanding into catkins, in spring (A. Brunner, pers. comm.). The abnormal flowers were formed in catkins positioned in leaf axils of new summer branches (Figure 8B). The catkins were long, straight and erect, and in opposite orientation to normal pendulous inflorescences of poplar (Figure 8B). On average, there were four catkins per flowering tree, with approximately 50 flowers per catkin. A mutant phenotype was seen on one catkin of event 191, where new leaflets had formed at the terminus of the withering catkin. The young shoots remained very small throughout the season, while the catkin axis hardened and thickened into a woody stem (Figure 8C). Floral buds were also observed on all four ramets from two other events in the field. A week after the first catkins expanded, we observed many additional floral buds on these four events (Figure 8D). Many remained unopened, but some did flush but without further development (Figure 8E).

All of the observed catkins carried female flowers as expected for clone 717-1B4, known to be a female tree. No male or bisexual flowers were observed on any of the catkins. A closer look at the flowers revealed ovules lining the inner sides of the carpel (

Figure 9A-D). In our attempt to investigate if the ovules were functional and if seeds had set, we sowed opened mature flowers onto a plate of sand in the greenhouse and incubated sterilized, unopened mature flowers onto ½-strength Murashige and Skoog (MS) media. No germinants were observed in either

experiment. Because the transgenic trees had flowered at the end of summer, when the poplar flowering period had long passed, and where no known, compatible wild poplars were growing nearby, likely for many kilometers, we strongly suspect there was no pollen and, thus, could be no fertilization, had the flowers been fertile and capable of supporting seed development.

To assess the expression levels of endogenous *PtCENL-1* in different transgenic events of *PtCENL-1* RNAi poplars, we performed RT-PCR analysis with 1 µg of total RNA isolated from young shoots pooled from two representative ramets per transgenic event. The four events identified as bearing flowers and/or floral buds in the field (events 27, 178, 183, and 191) showed pronounced silencing (Figure 10, Appendix M). RNA levels in all four events were less than 50% of RNA level detected in the untransformed controls. To confirm level of expression in these four events, we collected young new shoots (~ 1-2 cm long) from individual ramets from each of these four events. At the time of collection, the trees were actively growing in the field (summer 2005). We conducted reverse transcription once, on independent RNAs of two individual ramets per each event, and conducted real-time PCR twice on each cDNA sample. We obtained low levels of expression (< 50%) in each of the two ramets from the four lines (data not shown, Appendix M). We consider the gene to be effectively suppressed when its expression is reduced by at least 20% (Wesley et al., 2001).

### **Delayed vegetative bud-flush in poplars overexpressing *PtCENL-1***

Because our earlier work (Chapter 2) showed that *PtCENL-1* was mostly expressed in growing vegetative buds, and *PtMFT* in floral and vegetative dormant buds, we studied whether these genes have any effect on bud phenology. We recorded the Julian date when vegetative buds started to flush in spring following the first winter the trees were in the field. Based on means from all events in each transgenic group, the time of flushing differed significantly among the four

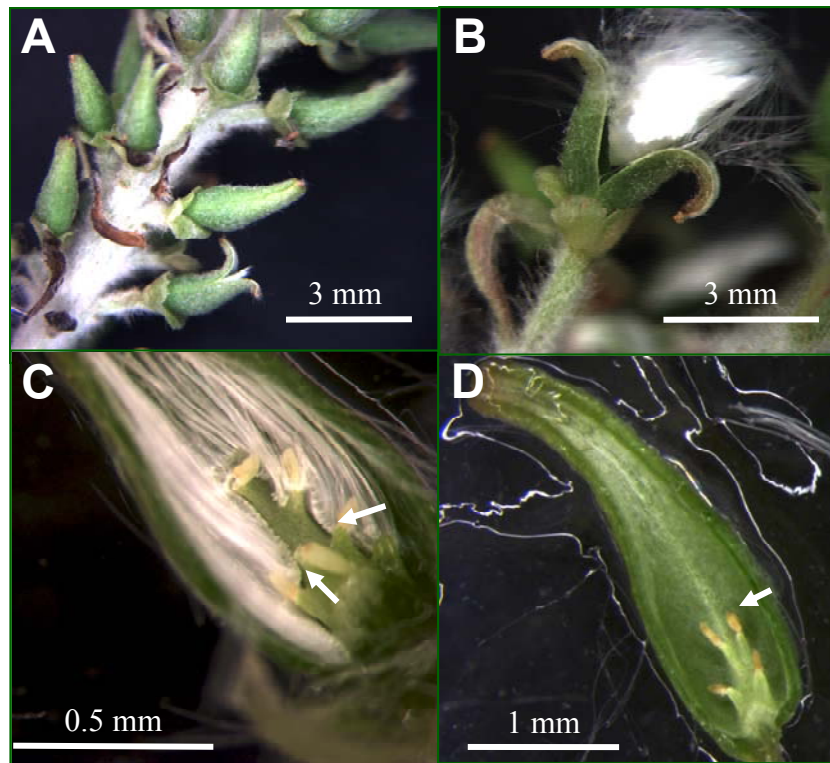

**Figure 9** Close-up view of flowers of poplar hybrid carrying the *PtCENL-1* RNAi construct. Flowers were taken from one of the catkins shown in Figure 8B. (A) Catkin bearing mature, unopened female flowers. (B) Female flower releasing its cotton. (C-D) Longitudinal section of a flower, revealing cotton and ovules (arrows) inside the carpel.

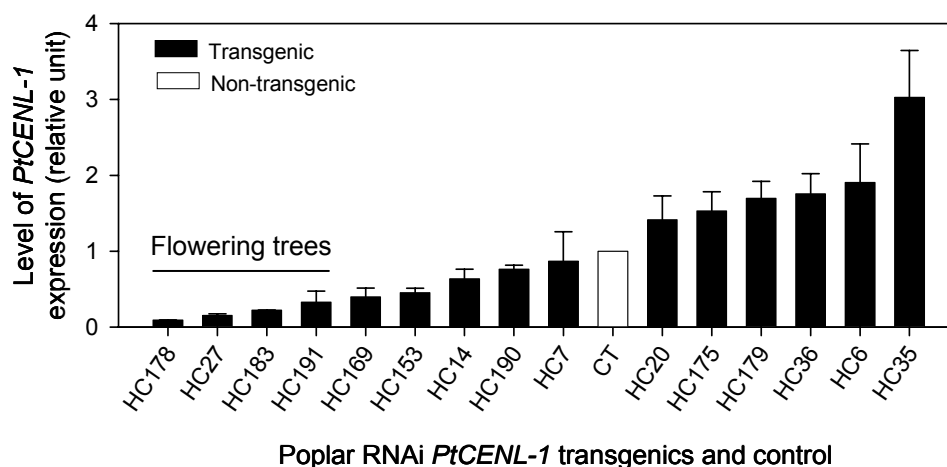

**Figure 10** Relative expression of native *PtCENL-1* in poplar transgenics carrying the *PtCENL-1* RNAi construct. Floral buds were detected in the first four events from the left, and early flowering were observed in events 178 and 191. cDNA was synthesized once per event, using 1 ug of total RNA extracted from young shoots pooled from two ramets from each event. Transcript quantities were determined by SYBR-green detection method and reported in relative to the non-transgenic control (CT, relative expression set to 1), and normalized to *UBQ* to control for loading errors. Bars are standard deviations over two real-time PCR runs using the same cDNA templates, with duplicate PCR reactions in each run.

transgenic varieties depending on the construct ( $p < 0.0001$ , Tukey-Kramer's test; Appendix M). The *35S::PtCENL-1* group flushed later when compared to non-transgenic trees ( $p < 0.0001$ ); *35S::PtCENL-1* trees flushed nine days after the non-transgenic trees, eight days after the *PtMFT* RNAi trees, six days after the *PtCENL-1* RNAi trees, and three days after the *35S::PtMFT* trees ( $p < 0.0001$ , Tukey-Kramer's test). There was no evidence that the two groups of RNAi trees had flushed differently from each other, or from the non-transgenic trees (Tukey-Kramer's test,  $\alpha = 0.05$ ). These transgenic varieties had flushed in the following order beginning with the early flushers: non-transgenic control, RNAi varieties, *35S::PtMFT*, and *35S::PtCENL-1* (Figure 11A).

Events within a construct also varied widely in flushing date ( $p < 0.0001$ ). Eight out of 19 events of the *35S::PtCENL-1* transgenic trees flushed late. These eight events flushed in a range of eight to 22 days after the non-transgenic controls

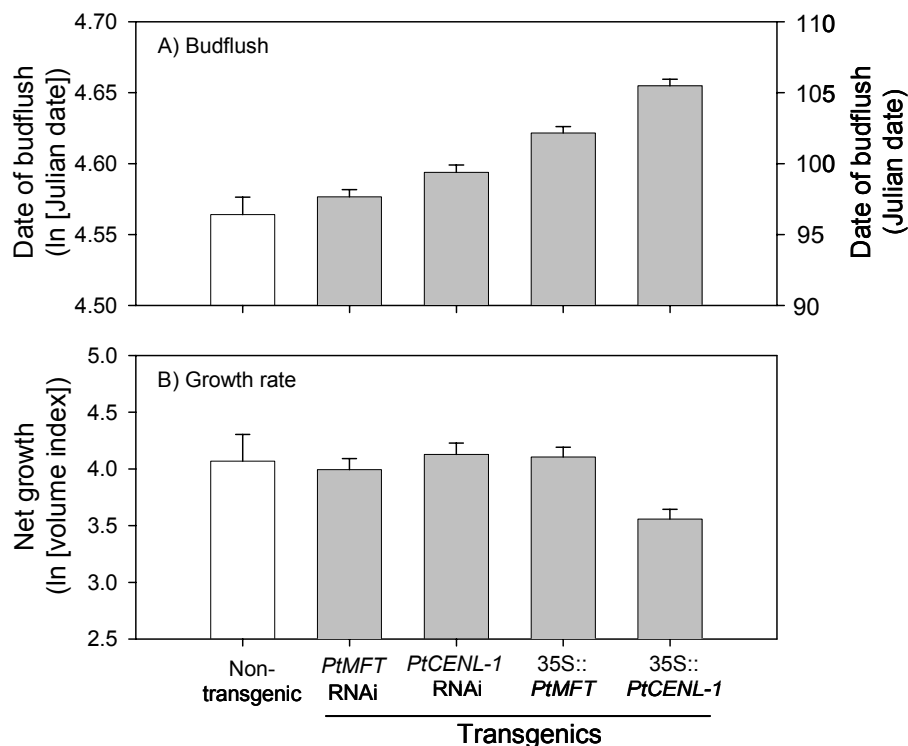

**Figure 11** Mean timing of budflush and mean net growth of field-grown transgenic *Populus tremula* x *P. alba* carrying four different constructs compared to non-transgenic controls. Data are means (in natural logarithm) from all events in each construct type. Standard errors for construct means are shown above bars.

( $p < 0.05$ , Dunnett's test; Appendix M). Although the 35S::*PtMFT* group flushed on average six days after the non-transgenics ( $p < 0.0001$ , Tukey-Kramer's test), only four out of the 19 events showed significant differences when compared to the non-transgenic trees (Dunnett's test,  $\alpha = 0.05$ ).

To evaluate biomass productivity of the transgenic trees, we analyzed tree growth by calculating the increment in volume index from the beginning to the end of one growing season in the field. Although trees carrying different constructs had different net growths (Figure 11B,  $p < 0.0001$ , Appendix M), no significant differences were detected when compared to the non-transgenic control trees (Tukey-Kramer's test,  $\alpha = 0.05$ ). Events within a construct had growth differences

( $p < 0.0001$ ); two events from the 35S::*PtCENL-1* trees (events 64 and 67) grew slower than the non-transgenic trees ( $p < 0.0009$ , Dunnett's test). No other transgenic events were significantly different in growth rate when compared to the control trees (Dunnett's test,  $\alpha = 0.05$ ).

We found a strong correlation between the timing of budflush and *PtCENL-1* overexpression from RT-PCR ( $r = 0.88$ ,  $p < 0.0001$ , Figure 12; Appendix M). As expected, the association with growth was negative, but non-significant ( $r = -0.39$ ,  $p < 0.096$ ). In the *PtCENL-1* and *PtMFT* RNAi trees, no association was found between the respective gene expression and budflush or growth (Appendix M). A significant association was detected between *PtMFT* transgene expression and tree growth in the 35S::*PtMFT* transgenic poplars. However, the positive relationship was weak ( $r = 0.50$ ,  $p < 0.035$ , Appendix M).

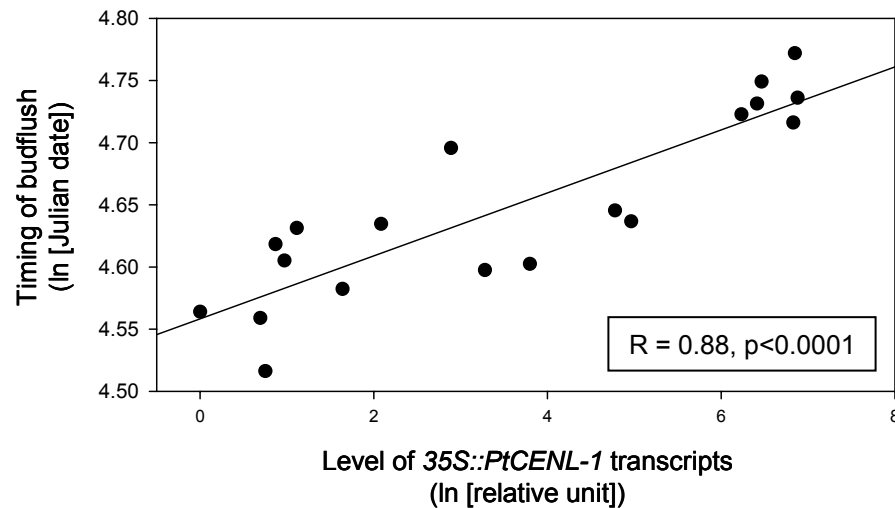

**Figure 12** Relationship between *PtCENL-1* transgene overexpression and the timing of budflush in two-year-old, field-grown transgenic *Populus tremula* x *P. alba*. Relative expression levels of 35S::*PtCENL-1* in individual transgenic events were based on real-time RT-PCR (RT-PCR). Total RNAs were extracted from a pool of newly flushed ~1cm leaflets collected from two ramets per transgenic event. Real-time PCR was repeated at least twice for each cDNA sample. The timing when the first bud flushed on individual trees in spring 2005 was recorded in Julian date.

## DISCUSSION

### ***PtCENL-1* and *PtMFT* are two functional flowering regulators**

Poplar *PtCENL-1* and *PtMFT* genes encode a protein with high homology to a group of plant PEBPs, including TFL1, CEN, and FT. *AtTFL1* and *AmCEN* proteins function to delay flowering and to maintain indeterminacy of inflorescence meristems, whereas the *AtFT* protein induces flowering (Bradley et al., 1996, 1997; Kobayashi et al., 1999). *AtMFT* in *Arabidopsis* acts similarly to *FT* in promoting flower development (Yoo et al., 2004).

Ectopic expression of *PtCENL-1* delayed the transition from the vegetative to the reproductive phase in *Arabidopsis* plants (Figure 7). *35S::PtCENL-1* plants exhibited an increased number of rosette leaves and an extended vegetative phase when compared to WT. The late/non-flowering group of *35S::PtCENL-1* plants showed a more extreme delay in flowering, or did not flower at all, compared to the transgenic events that flowered. These observed phenotypes were correlated with the abundance of the *PtCENL-1* transgene RNAs. In addition, subtending cauline leaves were absent in some transformants, while leaf-like structures were present on the shoots of the other transformants. Our results are consistent with findings in WT *Arabidopsis* plants that ectopically expressed *AtTFL1*: they show both delayed flowering and shoot-like structures in place of inflorescences (Bradley et al., 1996, 1997). Ectopic expression of *TFL1* homologs from other trees species, such as apple *MdTFL1* and citrus *CsTFL*, produce similar phenotypes (Pillitteri et al., 2004; Kotoda and Wada, 2005). Transformants that never flowered are also reported in *Arabidopsis* overexpressing ryegrass *TFL1*, and rice *CEN*-like genes (Jensen et al., 2001; Nakagawa et al., 2002). Interestingly, Jensen et al. (2001) and Pillitteri et al. (2004) reported a high density of trichomes on the adaxial leaf surface of transgenic *Arabidopsis* overexpressing ryegrass and citrus *TFL1*-like genes. In *Arabidopsis*, the disappearance of the trichomes from the adaxial side of the cauline leaves is a sign of the floral phase transition (Telfer and Poethig, 1998). In the *35S::PtCENL-*

*l* transformants expressing high levels of *PtCENL-1* RNAs, trichomes were not observed on either abaxial or adaxial sides of the leaves; instead the leaves were glossy and succulent. This suggests that *PtCENL-1* may play a role in maintaining reproductive-phase vegetative meristems in poplar.

Overexpression of *PtMFT* induced early flowering in *Arabidopsis*. However, the characteristic terminal flower phenotype, as in either *AtFT* overexpression or *AtTFL1* loss-of-function in *Arabidopsis*, was not observed in any of the transformants. A determinate primary inflorescence is also absent from *Arabidopsis* overexpressing *AtMFT* (Yoo et al., 2004). Because the morphology of the 35S::*PtMFT* transformants was similar to WT, we conclude that constitutive expression of *PtMFT* did not interfere with the functions of *AtFT* or *AtTFL1* genes.

*AtMFT* may act redundantly with *FT* in promoting flowering in *Arabidopsis* (Yoo et al., 2004). Genetic redundancy seems to be common in plants, especially among gene family members. Recently, another *TFL1* member in *Arabidopsis*, *AtTSF*, has been shown to act redundantly with *AtFT* in promoting flowering as well, though it seems to be required in short-day conditions (Yamaguchi et al., 2005). *PtMFT* may act redundantly with *AtFT* in *Arabidopsis*; its overexpression advanced flowering slightly, but was not sufficient to cause terminal flowers to form. In the poplar genome, there are at least four copies of *FT*-like genes (Chapter 2). Similar to *Arabidopsis*, *PtMFT* acts redundantly with *FT*-like genes to promote flowering in poplar.

### ***PtCENL-1* suppression promotes flowering in poplar**

Because *AtTFL1* overexpression causes late flowering, and *AtTFL1* loss-of-function leads to early flowering (Ratcliffe et al., 1998), we investigated whether *PtCENL-1* would have the corresponding effects in poplar. We produced transgenic poplars containing an RNAi construct to suppress native *PtCENL-1*, and planted the transgenic trees in the field. The genotype we studied, poplar hybrid

717-1B4, typically initiates floral buds in its sixth growing season at our field site (A. Brunner, pers.comm.). However, after being in the field for just two years, four out of 15 *PtCENL-1* RNAi events produced floral buds under natural conditions. These four events had low levels of native *PtCENL-1* transcripts, less than 50% of gene activity when compared to non-transgenic trees. In two out of the four events, some of the floral buds matured into full catkins rather than remaining as buds until after dormancy. However, flower elongation was arrested as the season progressed into fall and the weather turned cooler. This time of flowering is very unusual; typically poplar flowers at four to five years old, only once per year in the spring, just after the floral buds go through a period of required cold treatment (Brunner et al., 2004a).

By suppressing *PtCENL-1*, we speculate that the expression of floral meristem identity genes in poplar, similar to *Arabidopsis LFY* and *API*, is released from repression, thus promoting flower formation. In *Arabidopsis*, *AtTFL1* plays a role at the maintenance of inflorescence meristem identity by preventing the expression of *LFY* and *API* in the shoot apical meristems. Meanwhile, suppression of *AtTFL1* has the opposite effect (Liljegren et al., 1999). Under the photoperiod-dependant pathway, the *CONSTANS (CO)* gene, which encodes a transcription factor, plays a key role in controlling the onset of flowering (Putterill et al., 1995). *CO* activity is controlled by a circadian clock and long-day conditions increase *CO* transcripts. Induced expression of *CO* causes upregulation of *FT*, the direct target gene downstream of *CO*. *FT* is a floral promoter that acts on floral meristem identity genes, such as *API* and *LFY*. In contrast, *AtTFL1* inhibits the expression of floral identity genes.

We demonstrated that *PtCENL-1* suppression induces early flowering in *Populus* under summer conditions in a natural environment. This suggests promotion of flowering via the photoperiod-dependant pathway. Because native *PtCENL-1* expression was suppressed in *PtCENL-1* RNAi trees, floral meristem identity genes might be expressed without repression, leading to flowering.

However, the expression pattern of the transcription factor *CO*, and its direct downstream genes *FT*, *API*, and *LFY*, was not measured.

In two out of the four events where flowering was observed, the floral buds fully expanded in the same growing season as when they were formed. This seemed to occur without period of dormancy or a cold-treatment. It, therefore, appears that the transgenic trees bypassed their typical vernalization-like cold requirement. This suggests that *PtCENL-1* has a role in maintaining bud dormancy. A similar phenomenon was observed in transgenic poplars overexpressing a poplar homolog of the *Arabidopsis FT* gene (C. Yuceer, pers. comm.). In these transgenic trees, flowering was accelerated and a terminal flower formed. In addition, dormancy was not induced by exposure to short days.

### ***PtCENL-1* overexpression delays bud-flush in poplar**

Early flowering phenotypes observed in the *PtCENL-1* RNAi trees revealed functional similarity between poplar *PtCENL-1* and its homolog, *Arabidopsis TFL1*. However, does poplar *PtCENL-1* also extend vegetative phase like that observed in *Arabidopsis* overexpressing *TFL1* or in tobacco overexpressing *CEN?* To address this question, we produced 19 transgenic poplar events overexpressing *PtCENL-1* under the control of the 35S promoter and assessed their growth in the field. Despite high levels of *PtCENL-1* expression in most of them, growth of the transgenic events was not significantly different from the control plants (Figure 11B). We suspect that after several more growing cycles, a negative association would become apparent. It would be interesting to see if the same transgenic events also set bud early in fall. This would complement our present results, which indicate that *PtCENL-1* act as growth repressor in poplar.

Our results contrast with what has been observed in *Arabidopsis* expressing *TFL1*, where larger plants were observed due to delayed onset of flowering. In poplar, a temperate zone tree, overexpression of *PtCENL-1* appeared to retard

growth by shortening the growing season. Although *Arabidopsis TFL1* and poplar *PtCENL-1* are functionally similar in delaying flowering, they appeared to have opposing effects on plant size, that might be related to differences between annual growth cycle of a temperate woody perennial and an herbaceous annual.

### ***PtMFT* overexpression and suppression did not impart detectable phenotypes**

We produced overexpression and RNAi forms of *PtMFT* transgenic poplars and planted them in the field. Surprisingly, the transgenic trees did not produce any distinct phenotypes and were not significantly different from control plants in growth or timing of budflush (Figure 11A and Figure 11B). Earlier, we had shown that *PtMFT* is a functional gene; *Arabidopsis* plants ectopically expressing *PtMFT* flowered early. The overexpressed transgenic events did exhibit high levels of transgene *PtMFT* transcripts, and many of the RNAi transgenic events showed low levels of native *PtMFT* transcripts (Appendix M), indicating that changes from transgene expression, at least at the RNA level, were substantial.

Phylogenetic analysis grouped proteins encoded by *PtMFT* with *AtMFT* in an exclusive group different from *CEN* and *FT* members. *PtMFT* and *AtMFT* are highly similar in amino acid identity (78%). Interestingly, both contain tryptophan at position 83. This is one of the six positions identified by Banfield and Brady (2000) as ligand-binding sites that are highly conserved among plants' PEBPs. It has been demonstrated that the amino acid residue at this position defines PEBPs effect – a histidine resulting in TFL1-phenotypes, a tyrosine resulting in FT-like phenotypes, and a tryptophan resulting in weak FT-like phenotypes (Hanzawa et al., 2005). The weak FT-like effect we observed in *Arabidopsis* ectopically expressing *PtMFT* might, therefore, be explained by having tryptophan at this conserved position. Similar weak FT-like effects are also reported in *Arabidopsis* overexpressing *AtMFT* (Yoo et. al., 2004). Aside from flowering, perhaps *PtMFT* has another role in poplar. It has been suggested that *PtMFT* might be involved in

regulation of budset in poplars (A. Rohde, pers. comm.). *PtMFT* expression was strong in both floral and vegetative buds during dormancy induction (Chapter 2).

## Chapter 4: CONCLUSIONS

### MAJOR RESULTS

1. Two *P. trichocarpa* homologs of the *Arabidopsis* meristem identity gene *TFL1* have been cloned and their genomic and coding regions analyzed. The coding regions of *PtCENL-1* and *PtMFT* encode a protein with high homology to *Antirrhinum* CEN (77%) and *Arabidopsis* MFT (78%), respectively. *PtCENL-1* and *PtMFT* proteins share only 52% amino acid identity; placing them into two different clades in the phylogenetic tree. *PtCENL-1* groups together with TFL1/CEN-like proteins from various plant species, while *PtMFT* groups only with *AtMFT* in another clade, opposite from *PtCENL-1*. The phylogenetic clades suggest the two proteins might have different functions.
2. The expression patterns of *PtCENL-1* and *PtMFT* are very different. RT-PCR studies showed that *PtCENL-1* was expressed in all stages of developmental but was most strongly expressed in vegetative buds and shoot apices. *PtCENL-1* expression varied with season in the field. Expression was highest in vegetative buds in early spring prior to budflush, peaked in emerging shoots during budburst, and was weak in elongated shoots. Cold and short-day conditions suppressed expression but warm temperatures and long days induced expression. *PtMFT* was expressed in both vegetative and floral tissues at lower levels than *PtCENL-1*, but was not detected in vascular tissues. Transcripts were expressed preferentially in inflorescence buds. Expression was strong in vegetative and floral buds in fall. Cold and short-day conditions seemed to induce expression, while warm and long day suppressed expression. Differences in the expression profiles of these two genes suggest that they have very different functions.

3. Phylogenetic tree and expression analysis suggest that *PtCENL-1* and *PtMFT* might have opposing functions. We showed they have functional dissimilarities by overexpressing the two genes in *Arabidopsis*. Overexpression of *PtCENL-1* delayed onset of flowering in *Arabidopsis* plants, while overexpression of *PtMFT* accelerated the process.
4. Using a transgenic approach, we created overexpression and suppression varieties of these genes in hybrid poplars and planted them in the field for two years. The suppression of *PtCENL-1* promoted flowering in juvenile transgenic trees, while its overexpression was highly correlated with delayed budburst. Because flowering occurred under long-day conditions (late summer) in a natural environment, we suggest that promotion of flowering occurred via the photoperiod-dependant pathway. Long days induce *CO* gene activity, which acts directly on *FT* and floral meristem identity genes, while *PtCENL-1* suppression prevents repression of floral meristem identity genes. All four transgenic varieties showed no growth impairment, whereas the overexpressed *PtCENL-1* poplars are likely to show long-term growth impairment as a result of prolonged bud dormancy.
5. Overexpression and suppression forms of *PtMFT* trees did not show any distinct phenotypes when compared to non-transgenic control trees. *PtMFT* had a weak early-flowering effect when constitutively expressed in *Arabidopsis*. The weak effect is possibly due to the tryptophan residue at a conserved location (position 83) in its deduced amino acid sequence; this residue has been proposed to separate the function of *FT* from *TFL1* and *ATC* in *Arabidopsis* (Hanzawa et al., 2005). No effects were observed in transgenic poplars, despite high levels of transcripts in the overexpression trees and very low gene activity in the RNAi trees. Its high expression in inflorescence buds, and low expression in vegetative tissues, suggests that *PtMFT* may be involved in flowering. In addition, *PtMFT*'s strong expression in vegetative buds when induced by short days, and its weak expression when inhibited by long days, suggests a possible role in dormancy control. However, because the

overexpression and suppression of *PtMFT* did not cause any phenotypic differences from normal trees, it is likely that *PtMFT* acts redundantly with other genes having similar functions.

## MAJOR CONCLUSIONS

1. The two *P. trichocarpa* homologs of *Arabidopsis TFL1* gene are functional genes.
2. Their expression profiles differ in where and when they are expressed. *PtCENL-1* is preferentially expressed in vegetative buds under long days, while *PtMFT* is preferentially expressed in inflorescence buds under short days.
3. In respect to the onset of flowering, *PtCENL-1* and *PtMFT* in poplar are functionally similar to *TFL1* and *MFT*, in *Arabidopsis*, respectively. However, in a perennial tree, *PtCENL-1* and *PtMFT* might also be involved in controlling dormancy.
4. In poplar, *PtCENL-1* promotes early flowering when suppressed, and prolongs dormancy period when induced. We conclude that *PtCENL-1* is involved in flowering and dormancy control.
5. In poplar, *PtMFT* overexpression and suppression did not yield phenotypes that were any different than control trees, possibly because the gene is dispensable for normal poplar development.

## FUTURE RESEARCH SUGGESTIONS

Our goal for isolating the poplar *TFL1* homologs is to understand molecular mechanisms underlying floral induction in trees. Although we have learned much in genetic control of flowering from *Arabidopsis*, there are likely differences between trees and annual plants that we hope to elucidate. In this research, we have isolated two *P. trichocarpa* genes based on homology to *Arabidopsis TFL1*

gene. The cloning of flowering-time genes in poplar will allow their direct use in engineering bio-confinement to contain transgene movement, and in creating early-flowering clones for breeding purposes. These two genes are highly homologous to *Arabidopsis TFL1* genes but they do not necessarily have significant roles in the juvenile-to-reproductive phase transition and flowering in trees. We studied their functions by creating overexpression and suppression varieties in hybrid poplar. Among the four transgenic varieties, I would recommend to focus on the *PtCENL-1* RNAi trees. The RNAi trees could be potential candidates for breeding purposes due to their early flowering phenotypes and normal growth. However, the transgenic flowers appeared to be abnormal because they were borne on catkins that were displayed on shoots in the opposite orientation from normal catkins, which typically point downward. The flowers were greatly spaced although the number on each catkin was not necessarily reduced. A closer look at the precocious flowers showed that they had ovules just like normal female flowers. Whether the ovules were viable and receptive to pollination remained to be tested. We suspect more flowers will bloom from these transgenic events in the coming spring (2006). This is a good time to see if the RNAi trees bear any seeds from natural pollination in the field. Another question that should be addressed is whether *PtCENL-1* suppression affects the expression of floral identity genes, such as *FT* and *LFY*, and if genes acting directly upstream of *FT* and *LFY*, such as *CO*, are also induced under long-day conditions. The *PtCENL-1* RNAi transgenics can be used to test the function of other floral genes, and their interactions. Overexpressing poplar genes homologous to known floral inhibition genes, reverse the early-flowering phenotype. This will provide some insight into the flowering regulatory network in poplar.

Because *PtCENL-1* overexpression was highly correlated with late budburst, leading to a shorter growing season, silenced *PtCENL-1* trees possibly had a season that was of normal length if not longer. *PtCENL-1* overexpression trees may be useful for studying dormancy control in trees. It would be interesting if its overexpression also correlates with early budset. Perhaps the trees can be cut back

in winter and allowed to undergo another growing season to facilitate scoring. Alternatively, they can be grown in the greenhouse and allowed to set buds under controlled conditions.

Although *PtMFT* transgenics did not show any phenotype, the trees should be monitored as well. High-expresser events and strongly suppressed events can be selected based on our RT-PCR expression analysis, for further studies. Their growth in the field should be monitored for additional years. Perhaps the overexpressed trees will produce floral buds in a year or two.

Although the *PtCENL-1* transgenics have less potential for direct use in engineering transgene-containment, they can be used to test candidate genes of floral formation and dormancy regulation via transgenic studies. Poplar has an enormous amount of genomic resources such as expression profiles from microarray data. These profiles could lead to candidate genes that may be regulators of phase transition and bud formation/expansion.

Further analysis of vegetative and floral expression patterns should include other *CEN*-like and *FT*-like members identified from poplar genome sequence and microarray data as candidate regulators. To determine expression differences between juvenile and mature trees, tissues should be sampled from many more trees (replicates). A careful strategy should be employed so that all trees within a group are at a same developmental stage to reduce variances due to internal factors.

## BIBLIOGRAPHY

**Abe M, Kobayashi Y, Yamamoto S, Daimon Y, Yamaguchi A, Ikeda Y, Ichinoki H, Notaguchi M, Goto K, Araki T** (2005) *FD*, a bZIP protein mediating signals from the floral pathway integrator *FT* at the shoot apex. *Science* **309**: 1052–1056

**Amaya I, Ratcliffe O, Bradley D** (1999) Expression of *CENTRORADIALIS* (*CEN*) and *CEN*-like genes in tobacco reveals a conserved mechanism controlling phase change in diverse species. *Plant Cell* **11**: 1405–1417

**Banfield MJ, Brady RL** (2000) The structure of *Antirrhinum CENTRORADIALIS* protein (*CEN*) suggests a role as a kinase regulator. *J Mol Biol* **297**: 1159–1170

**Blázquez MA** (2005) The right time and place for making flowers. *Science* **309**: 1024–1025

**Bernier G, Havelange A, Houssa C, Petitjean A, Lejeune P** (1993) Physiological signals that induce flowering. *Plant Cell* **5**: 1147–1155

**Boss P, Bastow R, Mylne JM, Dean C** (2004) Multiple pathways in the decision to flower: enabling, promoting and resetting. *Plant Cell* **16**: S18–S31

**Braatne JH, Rood SB, Heilman PE** (1996) Life history, ecology, and conservation of riparian cottonwoods in North America. In, *Biology of Populus and its implications for management and conservation*. Part I, Chapter 3. Stettler RF, Bradshaw HD, Heilman PE, Hinckley TM, eds. NRC Research Press, National Research Council of Canada, Ottawa, ON. pp. 57–85

**Bradley D, Carpenter R, Copsey L, Vincent C, Rothstein S, Coen E** (1996) Control of inflorescence architecture in *Antirrhinum*. *Nature* **379**: 791–797

**Bradley D, Ratcliffe O, Vincent C, Carpenter R, Coen E** (1997) Inflorescence commitment and architecture in *Arabidopsis*. *Science* **275**: 80–83

**Bradshaw HD** (1998) Case history in genetics of long-lived plants: molecular approaches to domestication of a fast-growing forest tree: *Populus*. In, *Molecular Dissection of Complex Traits*. Paterson AH, ed. CRC Press, NY. pp. 219–228

**Bradshaw HD, Ceulemans R, Davis J, Stettler RF** (2000) Emerging model systems: Poplar (*Populus*) as a model forest tree. *Plant Growth Regul* **19**: 306–313

**Brunner AM, Goldfarb B, Busov VB, Strauss SH** (2003) Controlling maturation and flowering for forest tree domestication. In, *Transgenic Plants: Current Innovations and Future Trends*. Stewart CN, ed. Horizon Scientific Press, Wymondham, England, pp. 9–44

**Brunner AM, Busov VB, Strauss SH** (2004a) Poplar genome sequence: functional genomics in an ecologically dominant plant species. *Trends Plant Sci* **9**: 49–56

**Brunner AM, Yakovlev IA, Strauss SH** (2004b) Validating internal controls for quantitative plant gene expression studies. *BMC Plant Biology* **4**: 14–20

**Bustin SA** (2000) Absolute quantification of mRNA using real-time reverse transcription polymerase chain reaction assays. *J Mol Endocrinol* **25**: 169–193

**Carmel-Goren L, Liu YS, Lifschitz E, Zamir D** (2003) The *SELF-PRUNING* gene family in tomato. *Plant Mol Biol* **52**: 1215–1222

**Clough SJ, Bent AF** (1998) Floral dip: A simplified method for *Agrobacterium*-mediated transformation of *Arabidopsis thaliana*. *Plant J* **16**: 735–743

**DiFazio SP, Slavov GT, Burczyk J, Leonardi S, Strauss SH** (2004) Gene flow from tree plantations and implications for transgenic risk assessment. In, *Plantation Forest Biotechnology for the 21st Century*. Walter C, Carson M, ed. Research Signpost, Kerala, India, pp. 405–422

**FAO: Food and Agricultural Organization of the United Nations** (1985) Breeding poplars for disease resistance. *FAO Forestry Paper* **56**, Rome, Italy

**FAO: Food and Agricultural Organization of the United Nations** (1997) *State of the World's Forests*. Rome, Italy

**Filichkin SA, Meilan R, Busov VB, Brunner AM, Strauss SH** (in press) Alcohol-inducible gene expression in transgenic *Populus*. *Plant Cell Reports*

**Gleave AP** (1992) A versatile binary vector system with a T-DNA organisational structure conducive to efficient integration of cloned DNA into the plant genome. *Plant Mol Biol* **6**: 1203–1207

**Hanzawa Y, Money T, Bradley D** (2005) A single amino acid converts a repressor to an activator of flowering. *Proc Natl Acad Sci USA* **102**: 7748–7753

**Hayama R, Coupland G** (2004) The molecular basis of diversity in the photoperiodic flowering responses of *Arabidopsis* and rice. *Plant Physiology* **135**: 677–684

**Huang T, Boehlenius H, Eriksson S, Parcy F, Nilsson O** (2005) The mRNA of the *Arabidopsis* gene *FT* moves from leaf to shoot apex and induces flowering. *Science* **309**: 1694–1696

**James RR, DiFazio SP, Brunner AM, Strauss SH** (1998) Environmental effects of genetically engineered woody biomass crops. *Biomass and Bioenergy* **14**: 403–414.

**Jensen CS, Salchert K, Nielsen KK** (2001) A *TERMINAL FLOWER1*-like gene from perennial ryegrass involved in floral transition and axillary meristem identity. *Plant Physiol* **125**: 1517–1528

**Kardailsky I, Shukla VK, Ahn JH, Dagenais N, Christensen SK, Nguyen JT, Chory J, Harrison MJ, Weigel D** (1999) Activation tagging of the floral inducer *FT*. *Science* **286**: 1962–1965

**Kobayashi Y, Kaya H, Goto K, Iwabuchi M, Araki T** (1999) A pair of related genes with antagonistic roles in mediating flowering signals. *Science* **286**: 1960–1962

**Kojima S, Takahashi Y, Kobayashi Y, Monna L, Sasaki T, Araki T, Yano M** (2002) *Hd3a*, a rice ortholog of the *Arabidopsis FT* gene, promotes transition to flowering downstream of *Hd1* under short-day conditions. *Plant Cell Physiol* **43**: 1096–1105

**Kotoda N, Wada M** (2005) *MdTFL1*, a *TFL1*-like gene of apple, retards the transition from the vegetative to reproductive phase in transgenic *Arabidopsis*. *Plant Science* **168**: 95–104

**Kumar S, Tamura K, Jakobsen IB, Nei M** (2001) MEGA2: molecular evolutionary genetics analysis software. *Bioinformatics* **17**: 1244–1245

**Liljgren SJ, Gustafson-Brown C, Pinyopich A, Ditta GS, Yanofsky MF** (1999) Interactions among *APETALA1*, *LEAFY*, and *TERMINAL FLOWER1* specify meristem fate. *Plant Cell* **11**: 1007–1018

**Lang GA** (1987) Dormancy: A new universal terminology. *HortSci* **22**: 817–820

**Mimida N, Goto K, Kobayashi Y, Araki T, Ahn JH, Weigel D, Murata M, Motoyoshi F, Sakamoto W** (2001) Functional divergence of the *TFL1*-like gene

family in *Arabidopsis* revealed by characterization of a novel homologue. *Genes Cells* **6**: 327–336

**Nakagawa M, Shimamoto K, Kyojuka J** (2002) Overexpression of *RCN1* and *RCN2*, rice *TERMINAL FLOWER 1/CENTRORADIALIS* homologs, confers delay of phase transition and altered panicle morphology in rice. *Plant J* **29**: 743–750

**Ordidge M, Chiurugwi T, Tooke F, Battley NH** (2005) *LEAFY*, *TERMINAL FLOWER1* and *AGAMOUS* are functionally conserved but do not regulate terminal flowering and floral determinacy in *Impatiens balsamina*. *Plant J* **44**: 985

**Pena L, Martin-Trillo M, Juarez J, Pina J, Navarro L, Martinez-Zapater JM** (2001) Constitutive expression of *Arabidopsis LEAFY* or *APETALA1* genes in citrus reduces their generation time. *Nature Biotech* **19**: 263–267

**Pfaffl MW** (2001) A new mathematical model for relative quantification in real-time RT-PCR. *Nucleic Acids Res* **29**: 2002–2007

**Pillitteri LJ, Lovatt CJ, Walling LL** (2004) Isolation and characterization of a *TERMINAL FLOWER* homolog and its correlation with juvenility in citrus. *Plant Physiol* **135**: 1540–1551

**Pnueli L, Carmel-Goren L, Hareven D, Gutfinger T, Alvarez J, Ganai M, Zamir D, Lifschitz E** (1998) The *SELF-PRUNING* gene of tomato regulates vegetative to reproductive switching of sympodial meristems and is the ortholog of *CEN* and *TFL1*. *Development* **125**: 1979–1989

**Poethig RS** (1990) Phase change and the regulation of shoot morphogenesis in plants. *Science* **250**: 923–930

**Putterill J, Robson F, Lee K, Simon R, Coupland G** (1995) The *CONSTANS* gene of *Arabidopsis* promotes flowering and encodes a protein showing similarities to zinc finger transcription factors. *Cell* **80**: 847–857

**Ratcliffe OJ, Amaya I, Vincent CA, Rothstein S, Carpenter R, Coen ES, Bradley DJ** (1998) A common mechanism controls the life cycle and architecture of plants. *Development* **125**: 1609–1615

**Ratcliffe OJ, Bradley DJ, Coen ES** (1999) Separation of shoot and floral identity in *Arabidopsis*. *Development* **126**: 1109–1120

**Rottmann WH, Meilan R, Sheppard LA, Brunner AM, Skinner JS, Ma C, Cheng S, Jouanin L, Pilate G, Strauss SH** (2000) Diverse effects of

overexpression of *LEAFY* and *PTLF*, a poplar (*Populus*) homolog of *LEAFY/FLORICAULA*, in transgenic poplar and *Arabidopsis*. *Plant J* **22**: 235–245

**Rozen S, Skaletsky HJ** (2000) Primer3 on the WWW for general users and for biologist programmers. In: Krawetz S, Misener S (eds) *Bioinformatics Methods and Protocols: Methods in Molecular Biology*. Humana Press, Totowa, NJ. pp. 365–386

**Simpson GG** (2004) The autonomous pathway: epigenetic and post-transcriptional gene regulation in the control of *Arabidopsis* flowering time. *Plant Biology* **7**: 570–574

**Simpson GG, Dean C** (2002) *Arabidopsis*, the Rosetta stone of flowering time? *Science* **296**: 285–289

**Simpson GG, Gendall AR, Dean C** (1999) When to switch to flowering. *Annu Rev Cell Dev Biol* **99**: 519–550

**Suárez-López P, Wheatley K, Robson F, Onouchi H, Valverde F, Coupland G** (2001) *CONSTANS* mediates between the circadian clock and the control of flowering in *Arabidopsis*. *Nature* **410**: 1116–1120

**Sung S, Amasino RM** (2004) Vernalization in *Arabidopsis thaliana* is mediated by the PHD finger protein VIN3. *Nature* **427**: 159–164

**Taylor G** (2002) *Populus: Arabidopsis* for forestry. Do we need a model tree? *Ann Bot* **90**: 681–689

**Telfer A, Poethig RS** (1998) *HASTY*: A gene that regulates the timing of shoot maturation in *Arabidopsis thaliana*. *Development* **125**: 1889–1898

**Waterhouse PM, Helliwell CA** (2003) Exploring plant genomes by RNA-induced gene silencing. *Nat Rev Genet* **4**: 29–38

**Wesley SV, Helliwell CA, Smith NA, Wang MB, Rouse DT, Liu Q, Goodings PS, Singh SP, Abbott D, Stoutjesdijk PA, Robinson SP, Gleave AP, Green AG, Waterhouse PM** (2001) Construct design for efficient, effective and high-throughput gene silencing in plants. *Plant J* **6**: 581–590

**Wigge PA, Kim MC, Jaeger KE, Busch W, Schmid M, Lohmann JU, Weigel D** (2005) Integration of spatial and temporal information during floral induction in *Arabidopsis*. *Science* **309**: 1056–1059

- Wright LL, Berg S** (1996) Industry/government collaborations on short-rotation woody crops for energy, fiber and wood products. Proc., Bioenergy '96 - The Seventh National Bioenergy Conference: Partnerships to Develop and Apply Biomass Technologies, Nashville, TN, September 15–20, 1996
- Yamaguchi A, Kobayashi Y, Goto K, Abe M, Araki T** (2005) *TWIN SISTER OF FT (TSF)* acts as a floral pathway integrator redundantly with *FT*. *Plant Cell Physiol* **46**: 1175–1189
- Yano M, Kojima S, Takahashi Y, Lin H, Sasaki T** (2001) Genetic control of flowering time in rice, a short-day plant. *Plant Physiol* **127**: 1425–1429
- Yanovsky MJ, Kay SA** (2003) Living by the calendar: How plants know when to flower. *Nat Rev Mol Cell Biol* **4**: 265–275
- Yeung K, Seitz T, Li S, Janosch P, McFerran B, Kaiser C, Fee F, Katsanakis KD, Rose DW, Mischak H** (1999) Suppression of Raf-1 kinase activity and MAP kinase signaling by RKIP. *Nature* **401**: 173–177
- Yoo SY, Kardailsky I, Lee JS, Weigel D, Ahn JH** (2004) Acceleration of flowering by overexpression of *MFT (MOTHER OF FT AND TFL1)*. *Mol Cells* **17**: 95–101
- Zhang S, Hu W, Wang L, Lin C, Cong B, Sun C, Luo D** (2005) *TFL1/CEN*-like genes control intercalary meristem activity and phase transition in rice. *Plant Science* **168**: 1393–1408
- Zsuffa L, Giordano E, Pryor LD, Stettler RF** (1996) Trends in poplar culture: some global and regional perspectives. In, *Biology of Populus and its implications for management and conservation*. Part II, Chapter 20. Stettler RF, Bradshaw HD, Heilman PE, Hinckley TM, eds. NRC Research Press, National Research Council of Canada, Ottawa, ON. pp. 515–539

## **APPENDICES**

## **Appendix A A LARGE-SCALE CTAB ISOLATION OF DNA FROM POPLAR LEAVES**

This DNA extraction protocol was developed by Dr. Rick Meilan in the Forest Tree Biotechnology lab at Oregon State University, Corvallis, OR, USA, and is available at <http://zircote.forestry.oregonstate.edu/tgbb/protocols/extract.htm>.

### **Materials**

2X grinding buffer (ice-cold);

1% Sarkosyl solution;

Lysis buffer (ice-cold);

RNase A (10 mg/ml);

1% CTAB solution;

3 M sodium acetate (NaOAc);

5 M NaCl isopropyl alcohol (ice-cold);

10 mM Tris, pH 8.0;

1 mM EDTA (TE 10, 1);

Ethanol (70% and 100%);

Oakridge and 30-ml Corex tubes (1 each./sample);

Weighing paper funnels;

Phenol:chloroform:isoamyl alcohol (25:24:1);

Coffee grinder(s)

### **Steps for 8 samples**

1. Add sufficient vol. (190  $\mu$ l)  $\beta$ -mercaptoethanol to (95 ml) 2X grinding buffer to achieve final concentration of 0.2%. Cover and store on ice.

- 2 Add sufficient vol. (65  $\mu$ l)  $\beta$ -mercaptoethanol to (65 ml) lysis buffer to achieve final concn. of 0.1%. Cover and store on ice.
3. Excise ca. 2 g fresh apical tissue (from each tree, one at a time), roll up tissue, grasp with large forceps, freeze in liquid nitrogen and grind in a pre-chilled (with dry ice) coffee grinder in the presence of dry ice (N.B., rinse single-edge razor with EtOH between plants and clean coffee grinder thoroughly between samples, to prevent cross-contamination).
4. Transfer ground tissue/dry ice to Oakridge tube with a funnel fashioned out of weighing paper.
5. After the dry ice has all sublimed away, add 10 ml ice-cold 2X grinding buffer (with  $\beta$ -mercaptoethanol) and thoroughly grind tissue with the Polytron (N.B. I usually process eight samples at a time, in series, and grind each in sufficient dry ice so that after the eighth sample is done, there is little or no dry ice left in the first sample. In this way, I can proceed with this step right away. If sublimation is occurring too rapidly, it can be slowed by putting the tube on ice, but it is important to keep the samples cold).
6. Balance pairs of tubes using excess grinding buffer and centrifuge samples at 14,000 x g (in Sorvall at 10,000 rpm in SA-600 rotor) for 10 min. at 4 °C. Keep tubes on ice until they are centrifuged.
7. Pour off and discard the supernatant and resuspend the pellet in 7.5 ml ice-cold lysis buffer.
8. Add 1/10 vol. (750  $\mu$ l) of 10% Sarkosyl, shake vigorously and bring to room temperature.
9. Add 1/7 vol. (1.1 ml) 5 M NaCl and 3/10 vol. (2.25 ml) 1% CTAB solution, shake vigorously and incubate at 65 °C for 20 min, shaking tubes occasionally.
10. Add equal vol. (11.6 ml) phenol:chloroform:isoamyl alcohol, balance pairs of tubes, shake vigorously to form a emulsion, and spin in clinical tabletop at 3,000 rpm for 5 min. (room temperature).
11. Transfer the aqueous phase to a 30-ml Corex tube with a Pasteur pipette, add 2/3 vol. (8 ml) isopropanol, balance pairs of tubes with isopropanol, cover tubes with Parafilm, mix by repeated inversion, and store on ice for 20-30 min. Spin at 14,000 x g (10,000 rpm in SA-600 rotor) for 10 min. at 4 °C, pour off and discard supernatant. (N.B., the pellets can be covered and safely stored O.N. at -70 °C, if necessary.)

12. Resuspend the pellet (by repeated up and down motion, using a yellow pipette tip from which the end has been removed) in 600  $\mu$ l TE (10, 1), add 5  $\mu$ l 10 mg/ml RNase A, and incubate at 37 °C and 150 rpm for 4-5 hr.
13. Transfer sample to microfuge tube, add 1/10 vol. (60  $\mu$ l) of 3 M NaOAc, 700  $\mu$ l of phenol:chloroform:isoamyl alcohol, mix well.
14. Spin in microfuge at 14,000 x g for 5 min. and transfer whole aqueous phase to a new microfuge tube.
15. Repeat step 14 but only transfer ca. 500-600  $\mu$ l of aqueous to a new microfuge tube.
16. Add ca. 2 vol. (1 ml) 100% EtOH, chill samples at least 30 min on ice (or store overnight at -20 °C) then pellet DNA at 14,000 x g for 5 min.
17. Aspirate supernatant, wash pellet with 500  $\mu$ l ice-cold 70% EtOH, aspirate all traces of EtOH, being careful not to dislodge or aspirate the pellet, and air-dry pellet for at least 15 min. (Be sure to rinse the needle in dH<sub>2</sub>O between samples to avoid cross-contamination.)
18. Add 200  $\mu$ l TE (10, 1) and store at 4 °C until DNA dissolves. Remove tubes occasionally and gently flick to get DNA into solution faster. Do not vortex tubes or heat samples to facilitate dissolving process! Once DNA is completely dissolved, store at -20 °C.

## **Solutions**

### 2X Grinding Buffer (500 ml)

- 0.7 M sorbitol, 64 g
- 100 mM Tris (pH 8.0), 50 ml of 1 M
- 10 mM EDTA (pH 8.0), 10 ml of 500 mM
- 0.2% spermine tetrachloride, 1.0 g
- 0.2% spermidine trihydrochloride, 1.0 g
- 2% polyvinylpyrrolidone (PVP), 10 g
- 10% PEG 4000, 50 g

Lysis Buffer (250 ml)

0.35 M sorbitol, 16 g

50 mM Tris (pH 8.0), 12.5 ml of 1 M

25 mM EDTA (pH 8.0), 12.5 ml of 500 mM

1% polyvinylpyrrolidone (PVPP), 2.5 g

1% CTAB solution (100 ml)

1% CTAB, 1 g

0.7 M NaCl, 14.3 ml of 5 M

## Appendix B TOTAL RNA EXTRACTION PROTOCOL FOR POPLAR

This RNA extraction protocol is a modification to Qiagen's RNeasy mini kit. It was developed by Olga Shevchenko and Dr. Amy Brunner, in the Forest Tree Biotechnology lab at Oregon State University, Corvallis, OR, USA, and is available at <http://zircote.forestry.oregonstate.edu/tgbb/protocols/PoplarRNAextraction.pdf>. Yields vary depending on tissue type, tissue quality, and developmental stage. In our experience, yields have been as high as 1 mg and are usually at least 100 µg.

### Solutions

From Qiagen RNeasy mini kit and:

- Extraction buffer – add 0.01 g soluble polyvinylpyrrolidone (PVP-40 from Sigma) per 1 ml Qiagen RLT buffer
- 5M potassium acetate, pH 6.5

### Steps

1. Grind 0.2 g of frozen tissue to fine powder in mortar and pestle (in liquid nitrogen).
2. In a 30-50 ml round-bottom tube, add PVP-40 to 1 ml extraction buffer, add ground tissue, shake for 1 min, then homogenize with polytron for a ~ 30 sec.
3. Add 0.4 volume of 5M KoAc, pH 6.5, mix by inversion, incubate on ice 15 min.
4. Separate into two new 1.5 ml centrifuge tubes, ~ 0.7 ml in each tube, and spin at 12,000 rpm for 15 min at 4 °C.
5. Transfer supernatant to two new 1.5 ml tubes.
6. Add half volume of 100% ethanol to every tube, mix by pipetting.
7. Transfer to two RNeasy spin columns (pink) and follow Qiagen's instructions for Plant RNA isolation, starting with step 6.
8. For elution of RNA, use 30 µl RNase-free water, and repeat elution step.

## Appendix C GENOMIC SEQUENCE OF *PtCENL-1* AND *PtMFT*

Exons are underlined; introns are *italized*, start and stop codons are in **bold**. 5'-UTR and 3'-UTR sequences are partial.

### Genomic sequence of *PtCENL-1*

5' UTR

TACTATAGGG CACGCGTGGT CGACGGCCCG GGCTGGTATC  
**ATG**GCAAAGA TGTCAGAGCC TCTTGTGGTT GGGAGAGTGA TTGGAGATGT  
TATCGATCAT TTCACTGCAA ATGTGAAAAT GACAGTGACT TATCAGTCCA  
ACAGGAAGCA GGTTTTTAAT GGCCATGAGC TATTCCCATC TGCGGTAAC  
CATAAACCTA AAGTTGAGGT TCATGGAGGT GATATGAGAT CCTTTTTTAC  
CCTGGTATGA TATTTGTTCT TCCATGCCCA AGAGCTCTTT TTTCTTCTT  
TGATGTTGTT CTCACTGTAT AACCTTGATG GCTGCAGGTC ATGACAGACC  
CTGATGTTCC TGGTCCTAGT GATCCATACC TCAGGGAGCA CCTACACTGG  
TATATCAATT TCTCTAAATA ATCTCTTCAC CTATATGTAT AGAACTCAAG  
CTACCAAAGA ATTATTTCCA TTAATGATAA CTGTAAAACA AGTATTAATT  
GAATTCCAAG TAACAACCCA AAAATAGTTA AAAAAGCTGC CTCTATCATT  
TCCAGATTTT TCACACAACCT CAAGTAGAAA AGGTGTAATC ATGTAGAATA  
ATAAAAATAG TAAGAAAAAG TNCAGTTAAA ATCACATCCT CACTGCTTTA  
CCTTGATTTG ACCAATATCA TTACAGGATA GTAAGTGAACA TCCCAGGCAC  
CACAGATGCC ACATTTGGTA TGATTCTTCA CCCTGATCTA GGCTAGAGAG  
AGAAGTAATT ATCAGATGTG AAGAAGTAAT GATTTTTGAG GGTTTTCTTT  
TCCTTTTAAAT TATGACTACC TGCAGGAAGG GAAGTGATGA ACTATGAGAT  
GCCAAGGCCT AACATAGGGA TCCACAGGTT TGTTTTCCCTA CTTTTCAAGC  
AGAAGGGAAG GCAAACAGTG ACCACTCCAG CTTCAAGGGA CAAATTTAAC  
ACCAGGAAAT TCGCTGAAGA AAATGAGCTT GGCCTGCCTG TAGCCGCTGT  
CTTCTTCAAT GCCCAAAGGG AAACAGCGGC GAGGAAACGT **TGA**GGAGAAG  
 ATAA

3' UTR

TACAGGAATC AGAATGAATA ATGACCAATG CCAGCCAGCA TCATGCCCTAC  
 TATTGTACTA TCAAACCTGTA TTTGAACTTG ATGCAGGAGA AAGAAAATAAC  
 CCCGAAAAAA ATTAAA

Genomic sequence of *PtMFT*

5' UTR  
TACTATAGGG CACGCGTGGT CGACGGCCGG GCTGGTATCC ATGTGGCAGT  
CTCTGCTTCT ATTAACHTTA TGTTGCCCTA TGCATGGCTA GTAGGTCACA  
CTAATCCACG AGGCCAATTC ACCTTTTACG CTTCTATATA AGCAAGGCAC  
TGAAACTCT TTGAGTCACA CAGCAAACCA TCTTAAGAGG GTTTTCTCTC  
CTCTTGTTCT TACTCTTCTC TTGCAGTTGT TCTTTAGCTT TGATCTTGCT  
TTCGTTTTCC  
**ATG**GCTGCCT CTGTTGATCC TCTTGTTGTT GGTCGTGTTA TTGGTGATGT  
GGTTGATATG TTTGTCCCTG CTGTAAAAAT GTCTGTTTAT TATGGATCAA  
AGCATGTTAG CAATGGGTGT GATATTAAGC CTTCTTTGTC CGTGGACCCT  
CCCAAAGTGA CCATTTCTGG CCACTCTGAC GAGCTGTACA CTCTGGTTAG  
ATTTTAGCT GCGTATGTGT TTTTATGTT CTTGCATGCA GGTGTCTTTT  
ATGCTAAAAAT AATATGTACT GTGTTATTTT TCTCTTTGTT TGTGCATGTC  
GATCTGCTGG GATGCTGTGT TCGATTCTTG CAGATGATTA TACATATATC  
TAACAAGTG ATGACTGATC CTGATGCACC TAGCCCTAGT GAACCCAGAA  
TGCGAGAGTG GGTTCATTGG TATGTACTTT TGCAGGAAAA AAGAAGAAGA  
AAAAACACGT TGGATGACTC TTGTGATCTA GATTTATAGT TGAGAAAAAA  
CATAAACTT AACGTTTTGC TTCTTATTGT AGGATCGTTG CGGACATTCC  
TGGGGGCACA AACCCTACTC GAGTGAAAAAT ATATGAAACT TTACCTCTCT  
GATCTCTCTC TGTTTTGTTT TTTGAAAAAC ATCATCTGTT TCTTTACAAA  
CTAACTTCGA TCCTTTTATG ATCTCTTTAA TTTTCTCTAG TTTAACTTTT  
TCGTGACCAT ACACAAGTTG CATGCACGCA AAAACTTTGA GCTTATTTTC  
TACCTTTTTT TTTGTTGGTG GTCATGTTAC AAATTATCTC AAGAAGAAAT  
TTATTGGATT TGGTCTTTGG TCTTTTTTCC TTTTAAATTA GTAGAAAGAA  
GATCATCGTA TTCGTACAAA GCCCAAAGTT ATATCATTGC AAGAATTATT  
GCTGGAAATC AATGGGCATG AATGACANGT AGTCAGTAGA AGCAGCACTG  
GCCAAANCTA CTGNGGCTCC CACTGNTTTC ATAGCTAGGC ATGCCTCTTT  
ACTGCCAAAA CTTCCAGTTC TTTGTTTTTC TTTACTGTTA AGCAAATGCT  
TGGCAGAAAA TTAGAAGAAA AGGAAAAAAA TGACATGCAA GCACACACTA  
TTTCATGTCC CGCAGCTCGA AGTTTACATC ACAGCAATAA TTAACAAGAT  
AGTTTATAAT ATCTGAAACA AAATCTAGCC ATCAGGAAAC ACCATCCCAC  
AGTTTCATTT ATGAGAATTA ACATCTGTGT GAGTGAAAGT AGGCAGGAAT

ATTTTTCATT TTTTCCTCAC TGGCAGACAT GACCCCAGGG TGGCATATTG  
 GCAGTAATTT CTCTTCTCTT GCCACGTGTG CATTTGGTAA CGTATGCAAT  
 TTTTCCCGGT TCCCNGTCAT TGCATGTACA ATCCTATTAA CAAGTGGGTG  
 TCTGCATTGG CTACAAGTAT CACCCCCCAA CGTTGCCCTG AAGTTACACG  
 TCTCATGCCC CCTGTCACTT CCACNTCTAA AGCCTGTGGA AGCTNATATC  
 CTTACTGATA CNTGGCTATT ATAAGCTATC CACGGGGCAA GCATGCGCTA  
 TTCNTAAAAA TTGAGTTCAT GTAGATGATG CTTNNCTCCC CAGCTTGGGC  
 ATTCTCTTAT ATAAATAATT GGCATGTGTT ATTCTGCGGN CAATCCTANC  
 AGTTTTAATT ATCATTAGCT AGTGAAACAT AAATTTTTGA AAATTTATTT  
 CTTATTAATA GCAGAGAAAAG AAAGAGATAC TCTTTTGGTT AGATCACCAA  
 TCCTCTCAGA GTATATCTAG CTATACGCGA ATTCAAAAAA AGTACAAATA  
 TCACTTCTTA TACTGTGTAA ATGTTGCAAA TAAGCTTTGA TATCTATAAA  
 TGTTGGACGA GCTTGACAAA TATTTATGAA AAAATAACAA ATGTGAGTGC  
 GCAACATTAA TCATGGACAA TTCAGTTTGC TTGGTGCCAA GTRACTGCTGG  
 GCAATTATTG GTATAACTAA TGTTTGCAGG GAAAGAGATC CTTTCCTATG  
TTGGGCCTCG TCCGCCGGTG GGAATTCATC GCTACATACT GGTGCTTTTC  
CAGCAGAAGA TGCCGCTGGG GAGCATGGTG GAACCACCGC AGAACCGTTC  
TCATTTCAAC ACTCGACTCT ATGCTGCTCA TTTGGACCTG GGCCTGCCTG  
TTGCCACCGT CTACTTCAAT GCTCAGAAGG AGCCAGCAAA TAAGAGGCGC

**TAA**

3' UTR

GTTATTAAAT ACTCTGTGCA TGCTCGTTTCG GGGGCTAATA TAATAGCTAG  
 TATGCAATGG GCTCTAGAAA AATAA

## Appendix D DEDUCED AMINO ACID SEQUENCE ALIGNMENT OF DIFFERENT *TFL1* HOMOLOGS

CLUSTALW protein alignment for constructing Figure 3C. Identical residues are in black; conserved in gray. Dashes indicate gaps introduced in the alignment.

```

*          20          *          40          *
PdFtl1    : ----MPRDREPLSVGRVIGDVLDPEFTRSIISLRVNYNS----REVNNGCEL : 42
PtFtl1-1  : ----MPRDREPLSVGRVIGDVLDPEFTRSIISLRVNYNS----REVNNGCEL : 42
PtFtl1-3  : ----MPRDREPLSVGRVIGDVLDPEFTRSIISLRVNYNS----REVNNGCEL : 42
PtFtl1-4  : ----MPRDREPLSVGRVIGDVLDPEFTRSIISLRVNYNS----REVNNGCEL : 42
PnFtl1b   : ----MPRDREPLSVGRVIGDVLDPEFTRSIISLRVNYNS----REVNNGCEL : 42
PtFtl1-2  : ----MSRDRDPLSVGRVIGDVLDPEFTRSIISLRVNYNS----REVNNGCEL : 42
MdFtl     : ----MPRDRDPLVGRVIGDVLDPEFTRSVISLRVNYNS----KEVNNGCEL : 42
CiFtl     : ---MSSRERDPLVGRVIGDVLDPEFTRSIISLRVNYNS----KDVNNGREL : 43
OsHD3a    : -MAGSGRDRDPLVGRVIGDVLDPEFTRSIISLRVNYNS----KTVSNGCEL : 45
OsRft1    : -MAGSGRD-DPLVGRVIGDVLDPEFTRSIISLRVNYNS----RIVSNGCEL : 44
AtTsf     : ---MSLSRRDPLVGRVIGDVLDPEFTRSIISLRVNYNS----REVTNGLDL : 43
AtFtl     : ---MSINIRDPLVGRVIGDVLDPEFTRSIISLRVNYNS----REVTNGLDL : 43
OsFtl1-1  : -----MANDSLATGRVIGDVLDPEFTRSIISLRVNYNS----MPVLSGVEL : 42
PnTfl1d   : ----MAKMSEPLVGRVIGDVLDPEFTRSIISLRVNYNS----KQVFNGHEL : 44
PtCenl-1  : ----MAKMSEPLVGRVIGDVLDPEFTRSIISLRVNYNS----KQVFNGHEL : 44
PtCenl-2  : ----MANLSDPLVGRVIGDVLDPEFTRSIISLRVNYNS----KQVFNGHEL : 43
NtCet2    : ---MGSKMSDPLVGRVIGDVLDPEFTRSIISLRVNYNS----KHVYNGHEL : 44
LeSp      : ---MASKMCEPLVGRVIGDVLDPEFTRSIISLRVNYNS----KHVYNGHEL : 44
AmCen     : --MAAKISSDPLVGRVIGDVLDPEFTRSIISLRVNYNS----KHVYNGHEL : 48
AtCen     : ---MARISSDPLVGRVIGDVLDPEFTRSIISLRVNYNS----KQVFNGHEL : 44
OsFdr2    : ----MSRSVEPLVGRVIGDVLDPEFTRSIISLRVNYNS----KLVFNGHEL : 43
LpTfl1    : ----MSRSVEPLVGRVIGDVLDPEFTRSIISLRVNYNS----KLVFNGHEL : 43
OsFdr1    : ----MSRSVEPLVGRVIGDVLDPEFTRSIISLRVNYNS----KLVFNGHEL : 43
OsCen4    : ----MSRVLEPLVGRVIGDVLDPEFTRSIISLRVNYNS----KQVFNGHEL : 43
OsCen3    : ----MSRVLEPLVGRVIGDVLDPEFTRSIISLRVNYNS----KQVFNGHEL : 43
PsTfl1a   : ---MARMAQEPLVGRVIGDVLDPEFTRSIISLRVNYNS----QVFNGHEL : 43
CsTfl     : ---MAARMLEPLVGRVIGDVLDPEFTRSIISLRVNYNS----QVCNGHEL : 43
BnTfl1-1  : MENMGTRVIEPLVGRVIGDVLDPEFTRSIISLRVNYNS----QVSNGHEL : 46
BnTfl1-3  : MENMGTRVIEPLVGRVIGDVLDPEFTRSIISLRVNYNS----QVSNGHEL : 46
BrTfl1-1  : MENMGTRVIEPLVGRVIGDVLDPEFTRSIISLRVNYNS----QVSNGHEL : 46
AtTfl1    : MENMGTRVIEPLVGRVIGDVLDPEFTRSIISLRVNYNS----QVSNGHEL : 46
PtCenl-3  : ----MSRAMEPLVGRVIGDVLDPEFTRSIISLRVNYNS----QVANGYEF : 43
AtBft     : ----MSREIEPLVGRVIGDVLDPEFTRSIISLRVNYNS----IVSNGHEL : 43
AtMft     : ----MAASVDPLVGRVIGDVLDPEFTRSIISLRVNYNS----ITN-GCEI : 42
PtMft     : ----MAASVDPLVGRVIGDVLDPEFTRSIISLRVNYNS----VSN-GCEI : 42
OsTfl1    : ----MASHVDPLVGRVIGDVLDPEFTRSIISLRVNYNS----LTN-GCEI : 42
LeSP2G    : -METSARSVDPLVGRVIGDVLDPEFTRSIISLRVNYNS----ISNNGVEI : 46

```

	60	*	80	*	100						
PdFT1	: KPSHV	VNQPRVD	IGGE-	DLRTFY	TLVMV	DPDAPS	SPSNPN	LREY	LHWL	VTD	: 91
PtFTL-1	: KPSHV	VNQPRVD	IGGE-	DLRTFY	TLVMV	DPDAPS	SPSNPN	LREY	LHWL	VTD	: 91
PtFTL-3	: KPSHV	VNQPRVD	IGGE-	DLRTFY	TLVMV	DPDAPS	SPSNPN	LREY	LHWL	VTD	: 91
PtFTL-4	: KPSHV	VNQPRVD	IGGE-	DLRTFY	TLVMV	DPDAPS	SPSNPN	LREY	LHWL	VTD	: 91
PnFTLb	: KPSHV	VNQPRVD	IGGE-	DLRTFY	TLVMV	DPDAPS	SPSNPN	LREY	LHWL	VTD	: 91
PtFTL-2	: KPSQV	ANQPRVD	IGGE-	DLRTFY	TLVMV	DPDAPS	SPSDPS	LREY	LHWL	VTD	: 91
MdFT	: KPSEV	VQQPRAD	IGGD-	DLRTFY	TLVMV	DPDAPS	SPSDPN	LKEY	LHWL	VTD	: 91
CiFT	: KPSEV	LNQPRAE	IGGD-	DLRTFY	TLVMV	DPDAPS	SPSDPS	LREY	LHWL	VTD	: 92
OsHD3a	: KPSTM	VTHQPRVE	VGGN-	DMRTFY	TLVMV	DPDAPS	SPSDPN	LREY	LHWL	VTD	: 94
OsRFT1	: KPSTM	VTHQPRVE	VGGN-	DMRTFY	TLVMV	DPDAPS	SPSNPN	LREY	LHWL	VTD	: 93
AtTST	: RPSQV	LNKPIVE	IGGD-	DLRTFY	TLVMV	DPDAPS	SPSNPH	QREY	LHWL	VTD	: 92
AtFT	: RPSQV	QNKPRVE	IGGE-	DLRNFY	TLVMV	DPDAPS	SPSNPH	LREY	LHWL	VTD	: 92
OsFTL-1	: RAPA	VAEKPIVE	VGGD-	DLRVAY	TLVMV	DPDAEN	SPSNPT	LREY	LHWM	VTD	: 91
PnTFL1d	: FPSAV	THKPKVE	VHGG-	DMRSFF	TLVMT	DPDVFG	SPDPYL	REHL	LHWI	VTD	: 93
PtCENL-1	: FPSAV	THKPKVE	VHGG-	DMRSFF	TLVMT	DPDVFG	SPDPYL	REHL	LHWI	VTD	: 93
PtCENL-2	: FPSAV	THKPKVE	VHGG-	DMRSFF	TLVMT	DPDVFG	SPDPYL	REHL	LHWI	VTD	: 92
NtCET2	: FPSSV	TSKPRVE	VHGG-	DLRSFF	TMIMID	PDVFG	SPDPYL	REHL	LHWI	VTD	: 93
LeSP	: FPSSV	TSKPRVE	VHGG-	DLRSFF	TLVMT	DPDVFG	SPDPYL	REHL	LHWI	VTD	: 93
AmCEN	: FPSAV	TSTPRVE	VHGG-	DMRSFF	TLVMT	DPDVFG	SPDPYL	REHL	LHWI	VTD	: 97
AtCEN	: FPSV	VTYKPKVE	VHGG-	DMRSFF	TLVMT	DPDVFG	SPDPYL	REHL	LHWI	VTD	: 93
OsFDR2	: YPSAV	VSKPRVE	VQGG-	DLRSFF	TLVMT	DPDVFG	SPDPYL	REHL	LHWI	VTD	: 92
LpTFL1	: YPSAV	VSKPRVE	VQGG-	DLRSFF	TLVMT	DPDVFG	SPDPYL	REHL	LHWI	VSN	: 92
OsFDR1	: YPSAV	VSKPRVE	VQGG-	DMRSFF	TLVMT	DPDVFG	SPDPYL	REHL	LHWI	VTD	: 92
OsCEN4	: FPSAV	VSKPRVE	VQGG-	DLRSFF	TLVMT	DPDVFG	SPDPYL	REHL	LHWI	VTD	: 92
OsCEN3	: FPSAV	AGKPRVE	VQGG-	DLRSFF	TLVMT	DPDVFG	SPDPYL	REHL	LHWI	VTD	: 92
PstTFL1a	: FPSTI	NTKPKVE	IDGA-	DMRSFY	TLVMT	DPDVFG	SPDPYL	REHL	LHWI	VTD	: 92
CsTFL	: FPSTI	VSKPRVE	IQGG-	DMRSFF	TLVMT	DPDVFG	SPDPYL	REHL	LHWI	VTD	: 92
BnTFL1-1	: FPLAV	VSSKPRVE	IHDG-	DLRSFF	TLVMT	DPDVFN	PSDPFL	KERL	LHWL	VMN	: 95
BnTFL1-3	: FPLAV	VSSKPRVE	IHDG-	DLRSFF	TLVMT	DPDVFN	PSDPFL	KERL	LHWL	VMN	: 95
BrTFL1-1	: LPLAV	VSSKPRVE	IHDG-	DLRSFF	TLVMT	DPDVFN	PSDPFL	KERL	LHWL	VMN	: 95
AtTFL1	: FPSSV	VSSKPRVE	IHGG-	DLRSFF	TLVMT	DPDVFG	SPDPFL	KEHL	LHWI	VTN	: 95
PtCENL-3	: MPSVI	IAYKPRVE	IGGE-	DMRTAY	TLVMT	DPDAPS	SPSDPY	LREHL	LHWM	VTD	: 92
AtBFT	: APSL	L LSKPRVE	IGGQ-	DLRSFF	TLVMT	DPDAPS	SPSNPY	MREY	LHWM	VTD	: 92
AtMFT	: KPSTAV	NPKVN	ISG--	HSDELY	TLVMT	DPDAPS	SPSEPN	MREW	VHWI	VVD	: 90
PtMFT	: KPSSL	SVDPKVT	ISG--	HSDELY	TLVMT	DPDAPS	SPSEPR	MREW	VHWI	VAD	: 90
OsTFL1	: KPSVAA	APAVQ	IAG--	RWNELF	ALVMT	DPDAPS	SPSEPT	MREW	LHWL	VVN	: 90
LeSP2G	: KPAEAA	QKPRVH	IKGSL	HSNNLY	TLVMAD	PDAPS	SPSEPT	FRWL	LHWI	VTD	: 96

```

*           120           *           140           *
PdFT1      : IPATTGANFGQEVVCYESPRPTAGIHREVFVLFRLQGRQTVYPPG---WR : 138
PtFTL-1    : IPATTGANFGQEVVCYESPRPTAGIHREVFVLFRLQGRQTVYPPG---WR : 138
PtFTL-3    : IPATTGANFGQEVVCYESPRPTAGIHREVFVLFRLQGRQTVYPPG---WR : 138
PtFTL-4    : IPATTGANFGQEVVCYESPRPTAGIHREVFVLFRLQGRQTVYPPG---WR : 138
PnFTLb     : IPATTGANFGQEVVVCYESPRPTAGIHREVFVLFRLQGRQTVYAPG---WR : 138
PtFTL-2    : IPATTGASFGHETVVCYESPRPTMGIHREVFVLFRLQGRQTVYAPG---WR : 138
MdFT       : IPATTAASEFGQEVVVCYESPRPTVGIHREVLVLFRLQGRQTVYAPG---WR : 138
CiFT       : IPATTGASFGQEVVNYESPRPTMGIHREVFVLFRLQGRQTVYAPG---WR : 139
OsHD3a     : IPGTTAASEFGQEVVVCYESPRPTMGIHRLVLFRLQGRQTVYAPG---WR : 141
OsRFT1     : IPGTTGATFGQEVVVCYESPRPTMGIHRLVLFRLQGRQTVYAPG---WR : 140
AtTSF      : IPATTGNAFNGNEVVCYESPRPESGIHRIVLVLFRLQGRQTVYAPG---WR : 139
AtFT       : IPATTGTTFGNEIVCYENPSETAGIHRVVFILFRLQGRQTVYAPG---WR : 139
OsFTL-1    : IPASTDATYGREVVVCYESPNPTTGIHRMVLVLFRLQGRQTVYAPA---VR : 138
PnFTL1d    : IPGTTDATFGREVMNYEMPRPNI GIHREVFVLLFKQKGRQTVTTPA---SR : 140
PtCENL-1   : IPGTTDATEFGREVMNYEMPRPNI GIHREVELLFKQKGRQTVTTPA---SR : 140
PtCENL-2   : IPGTTDATEFGREVVNYEMPRPNI GIHREVVYLLFKQKGRQTVSTPS---SR : 139
NtCET2     : IPGTTDCSFGKEIVGYEMPRPNI GIHREVELLFKQKRRQTVLTAP--LSR : 141
LeSP       : IPGTTDCSFGREVVGYEMPRPNI GIHREVFVLLFKQKRRQTISSAP--VSR : 141
AmCEN      : IPGTTDSFSGKEVVSYEMPRPNI GIHREVELLFKQKRRGQAMLSPPVVC : 147
AtCEN      : IPGTTDVSGKEIIGYEMPRPNI GIHREVVYLLFKQTRRGSVVSV--SYR : 141
OsFDR2     : IPGTTDASFGREVISYESPKNIGIHRIFVLFKQKRRQTVIVPS---FR : 139
LpTFL1     : IPGTTDASFGGEVMSYESPKNIGIHRIFVLFKQKRRQTVSVPS---FR : 139
OsFDR1     : IPGTTDASFGREIISYESPKPSIGIHRIFVLFKQKRRQAVVPS---SR : 139
OscEN4     : IPGTTDASFGREVVSYESPKNIGIHRFVLLVLFKQKRRQAVTTPS---SR : 139
OscEN3     : IPGTTDASFGREVVSYESPKNIGIHRIFVLFKQKRRQAVSPPP---SR : 139
PsTFL1a    : IPGTTDATEFGKEIVSYELPKPNI GIHREVFVLFKQRRAR-DSVRAT-PSSR : 140
CsTFL      : IPGTTDATEFGREIVSYELPKPNI GIHREVFVLFKQTRR-QTVN--PSSR : 139
BnTFL1-1   : IPGTTDATEFGKEVVSYELPKPNI GIHRYVEVLFKQKRRVKFPPSN-IISR : 144
BnTFL1-3   : IPGTTDATEFGKEVVSYELPKPNI GIHRYVEVLFKQKRRVKFPPSN-IISR : 144
BrTFL1-1   : IPGTTDATEFGKEVVSYELPKPNI GIHRYVEVLFKQKRRVKFPPSN-IISR : 144
AtTFL1     : IPGTTDATEFGKEVVSYELPRPSIGIHRIFVLFKQKRRVIFPN--IPSR : 143
PtCENL-3   : IPGTTDVSGREIVSYETPKPVVGIHRYVEILFKQGRQTVRAP--ASR : 140
AtBFT      : IPGTTDASFGREIVRYETPKPVAGIHRVVEALFKQGRQAVKAAP--ETR : 140
AtMFT      : IPGGTNPTRGKEILSYMPRPVGIHRYILVLFKQNSPVGLMVQ-QPPSR : 139
PtMFT      : IPGGTNPTRGKEILSYVGRPPVGIHRMILVLFKQKMPGLSMVE-PPQNR : 139
OsTFL1     : IPGGTDPSQGDVVVPMGPRPPVGIHRYVMVLFKQKAVVAAPPPDEDAAAR : 140
LeSP2G     : IPEGGDASQGREMVEYMGPKPPAGIHRMVEILFKQKEAEQVPHK-PPQGR : 145

```

```

                                160          *          180          *
PdFT1      : QNFNTRDFAELYNLGSPVAAVYFNCORESGSGGRRP----- : 174
PtFTL-1    : QNFNTRDFAELYNLGSPVAAVYFNCORESGSGGRRP----- : 174
PtFTL-3    : QNFNTRDFAELYNLGSPVAAVYFNCORESGSGGRRP----- : 174
PtFTL-4    : QNFNTRDFAELYNLGSPVAAVYFNCORESGSGGRRP----- : 174
PnFTLb     : QNFNTRDFAELYNLGSPVAAVYFNCORESGSGGRRP----- : 174
PtFTL-2    : QNFNTRDFAEVYNLGSPVAAVYFNCORESGSGGRRR----- : 174
MdFT       : QNFNTRDFAELYNLGLPVSIVYFNCOREGGSGGRRR----- : 174
CiFT       : QNFSTRDFAELYNLGPPVAAVYFNCORESGSGGRRPVRR----- : 177
OsHD3a     : QNFNTRKDFAEYNLGSPVAAVYFNCOREAGSGGRRVYP----- : 179
OsRFT1     : QNFSTRNFAELYNLGSPVATVYFNCOREAGSGGRRVYP----- : 178
AtTSE      : QQFNTRFAEIYNLGLPVAASVYFNCORENGCGGRRRT----- : 175
AtFT       : QNFNTRFAEIYNLGLPVAAVFYFNCORESGCGGRRRL----- : 175
OsFTL-1    : HNFNTRAFARYNLGAPVAAVYFNCOROAGSGGRRFTGPYTSRRRQA : 185
PnTFL1d    : DKFNTRKFAEENELGLPVAAVFFNAORETAARKR----- : 174
PtCENL-1   : DKFNTRKFAEENELGLPVAAVFFNAORETAARKR----- : 174
PtCENL-2   : DKFNTRKFAEENELDL PVAAVFFNAORETAARRR----- : 173
NtCET2     : DRFNTRKFAEENELGSPVAAVFFNCORETAARRR----- : 175
LeSP       : DQFSSRKFAEENELGSPVAAVFFNCORETAARRR----- : 175
AmCEN      : DGFNTRKFTQENELGLPVAAVFFNCORETAARRR----- : 181
AtCEN      : DQFNTRFAHENDLGLPVAAVFFNCORETAARRR----- : 175
OsFDR2     : DHFNTRRFAEENDLGLPVAAVYFNAORETAARRR----- : 173
LpTFL1     : DHFNTRQFAVDNDLGLPVAAVYFNCORETAARRR----- : 173
OsFDR1     : DHFNTRQFAEENELGLPVAAVYFNAORETAARRR----- : 173
OscEN4     : DYFSTRRFAADNDLGLPVAAVYFNAORETAARRR----- : 173
OscEN3     : DRFNTRQFAEDNDLGLPVAAVYFNAORETAARRR----- : 173
PsTFL1a    : DHFNTRSFASQNDLGLPVAAVYFNAORETAARRR----- : 174
CsTFL      : DHFNTRFAAENDLGLPVAAVYFNAORETAARRR----- : 173
BnTFL1-1   : DQFNTRFAIENDLGLPVAAVFFNAORETASRRR----- : 178
BnTFL1-3   : DQFNTRFAIENDLGLPVAAVFFNAORETASRRR----- : 178
BrTFL1-1   : DQFNTRFAIENDLGLPVAAVFFNAORETASRRR----- : 178
AtTFL1     : DHFNTRKFAVEYDLGLPVAAVFFNAORETAARKR----- : 177
PtCENL-3   : DCFNTRMFAGENGLGLPVAAVYFNAORETAARRR----- : 174
AtBFT      : ECFNTNAFSSYFGLSQPVAAVYFNAORETAPRRRPSY----- : 177
AtMFT      : ANFNTRMFAGHFDLGLPVATVYFNAOKEPASRRR----- : 173
PtMFT      : SHFNTRLIAAHLDLGLPVATVYFNAOKEPANKRR----- : 173
OsTFL1     : ARFNTRAFADRHDLGLPVAALYFNAOKEPANRRRRY----- : 176
LeSP2G     : SNFKTRQFASDNGLDLPVAALYFNSSOKEHAAHH----- : 178

```

Percentage (%) of amino acid identity between the deduced amino acids of *PtCENL-1* and *PtMFT* compared to those belonging to other *FT/TFL-1* homologs.

<b>Gene</b>	<b>Species</b>	<b><i>PtCENL-1</i></b>	<b><i>PtMFT</i></b>
<i>PnTFL1d</i>	<i>Populus nigra TFL1d</i>	100	52
<i>PtCENL-1</i>	<i>Populus trichocarpa CENL-1</i>	100	52
<i>PtCENL-2</i>	<i>Populus trichocarpa CENL-2</i>	91	53
<i>MdTFL1</i>	<i>Malus domestica TFL1</i>	79	53
<i>NtCET2</i>	<i>Nicotiana tabacum CEN-L</i>	79	50
<i>OsFDR1</i>	<i>Oryza sativa FDR1</i>	79	54
<i>OsCEN3</i>	<i>Oryza sativa CEN3</i>	79	53
<i>OsFDR2</i>	<i>Oryza sativa CEN-L</i>	78	55
<i>CsTFL</i>	<i>Citrus sinensis TFL</i>	78	54
<i>LeSP</i>	<i>Lycopersicon esculentum SP</i>	77	46
<i>AtCEN</i>	<i>Arabidopsis thaliana CEN</i>	77	54
<i>AmCEN</i>	<i>Antirrhinum majus CEN</i>	77	52
<i>OsCEN4</i>	<i>Oryza sativa CEN4</i>	76	53
<i>LpTFL1</i>	<i>Lolium perenne TFL1</i>	74	54
<i>PstTFL1a</i>	<i>Pisum sativum TFL1a</i>	74	53
<i>AtTFL1</i>	<i>Arabidopsis thaliana TFL1</i>	72	50
<i>PtCENL-3</i>	<i>Populus trichocarpa CENL-3</i>	70	53
<i>BnTFL1-1</i>	<i>Brassica napus TFL1-1</i>	68	49
<i>BnTFL1-3</i>	<i>Brassica napus TFL1-1</i>	68	49
<i>BrTFL1-1</i>	<i>Brassica rapa TFL1-1</i>	67	49
<i>OsDH3a</i>	<i>Oryza sativa HD3a</i>	62	50
<i>AtBFT</i>	<i>Arabidopsis thaliana BFT</i>	61	49
<i>PnFT1b</i>	<i>Populus nigra FT1b</i>	59	49
<i>PdFT1</i>	<i>Populus deltoides FT1</i>	59	49
<i>PtFTL-1</i>	<i>Populus trichocarpa FTL-1</i>	59	49
<i>PtFTL-2</i>	<i>Populus trichocarpa FTL-2</i>	59	49
<i>PtFTL-3</i>	<i>Populus trichocarpa FTL-3</i>	59	49
<i>PtFTL-4</i>	<i>Populus trichocarpa FTL-4</i>	59	49
<i>CuFT</i>	<i>Citrus unshiu FT</i>	58	46
<i>OsRFT1</i>	<i>Oryza sativa RFT1</i>	58	50
<i>MdFT</i>	<i>Malus domestica FT</i>	56	50
<i>AtTSF</i>	<i>Arabidopsis thaliana TSF</i>	56	48
<i>AtFT</i>	<i>Arabidopsis thaliana FT</i>	56	45
<i>OsFTL-1</i>	<i>Oryza sativa FTL-1</i>	54	42
<i>AtMFT</i>	<i>Arabidopsis thaliana MFT</i>	50	78
<i>OsTFL1</i>	<i>Oryza sativa putative TFL1</i>	50	63
<i>LeSP2G</i>	<i>Lycopersicon esculentum SP2G</i>	50	57

## Appendix E MEMBERS OF THE POPLAR *TFL1* GENE FAMILY

Poplar *TFL1* gene family members were identified by homology using the BLAST program (Altschul et al., 1997) at the Department of Energy - Joint Genome Institute (DOE-JGI) website

([http://shake.jgi-psf.org/Poptr1\\_1/Poptr1\\_1.home.html](http://shake.jgi-psf.org/Poptr1_1/Poptr1_1.home.html)) on August 31, 2005. The full-length coding sequence of *PtCENL-1* was used in searches against the *P. trichocarpa* Jamboree Gene Models using the alignment TBLASTX program (BLAST nucleotide vs. translated nucleotide). BLAST hits revealed eight different genes, all of which were aligned (Appendix D) using the CLUSTALW program.

The eight gene names are listed below in the left column following DOE-JGI annotation system, while our designations are in the right column. cDNA sequences of *PtCENL-1* and *PtMFT*, matched exactly to that of estExt\_fggenes4\_pg.C\_660171 and fggenes4\_pg.C\_LG\_XV000341, respectively.

JGI designation	New designation
estExt_fggenes4_pg.C_660171	<i>PtCENL-1</i>
grail3.0001004901	<i>PtCENL-2</i>
eugene3.001511192	<i>PtCENL-3</i>
fggenes4_pg.C_scaffold_1444000001	<i>PtFTL-1</i>
fggenes4_pg.C_LG_VIII000671	<i>PtFTL-2</i>
eugene3.14090001	<i>PtFTL-3</i>
fggenes4_pm.C_LG_X000701	<i>PtFTL-4</i>
fggenes4_pg.C_LG_XV000341	<i>PtMFT</i>

*PtCENL* = *P. trichocarpa* CENTRORADIALIS (CEN)-like genes

*PtFTL* = *P. trichocarpa* FLOWERING LOCUS T (FT)-like genes

*PtMFT* = *P. trichocarpa* MOTHER OF FT AND TFL1 (MFT)

## Appendix F RNA SOURCE, TISSUE TYPES, AND EXPRESSION DATA

### A) *PtCENL-1* and *PtMFT* expression in various organs.

The different tissues were obtained either from wild *Populus trichocarpa* growing in the vicinity of Corvallis, Oregon, USA or from *P. trichocarpa* Nisqually-1, planted in the field at Marchel Tract, near Corvallis. Seedlings were germinated in the lab using seeds collected from wild trees. Total RNA samples were obtained from Dr. Palitha Dharmawardhana at the Department of Forest Science, Oregon State University. Real-time PCR experiments were as described in Materials and Methods (Chapter 2). *PtCENL-1* and *PtMFT* expressions are in relative units; SD = one standard deviation over four replicate measurements; ND = not detected.

**Table F 1** Relative expression (RE) of native *PtCENL-1* and *PtMFT* in different tissue types. RE was re-scaled to the sample with the lowest expression, which was set to 1.

Tissue type	<i>PtCENL-1</i> ± SD	<i>PtMFT</i> ± SD
<b>Floral</b>		
Female flower post-pollination in March	4.22 ± 0.73	1.52 ± 0.15
Elongated male flower at three different stages in March	1	1
Female new inflorescence bud in June	3.42 ± 0.84	10.33 ± 3.21
Male new inflorescence bud in June	3.69 ± 0.66	73.57 ± 14.15
<b>Vegetative</b>		
New vegetative shoots, < 1½" long, emerged in early spring (April)	101.22 ± 34.76	22.80 ± 3.51
Shoot apices in June	926.11 ± 9.08	28.88 ± 4.72
New vegetative buds in June	1640.73 ± 429.25	23.41 ± 3.15
Mature leaves in June	2.71 ± 1.52	28.17 ± 5.42
Xylem	21.31 ± 0.89	ND
Phloem	3.20 ± 0.81	ND
Seedling 43 hr after imbibition	16.28 ± 0.48	41.71 ± 8.43

**B) *PtCENL-1* and *PtMFT* expression in various floral and vegetative tissues collected at different time points over a growing season.**

Expression data of *PtCENL-1* and *PtMFT* in various tissue types collected across a seasonal cycle is given below. Total RNA extraction, cDNA synthesis and RT-PCR experiments were as described in Materials and Methods, Chapter 2.

*PtCENL-1* and *PtMFT* expressions are in relative units; SD = one standard deviation over duplicate PCR reaction for each gene/sample combination from one RT-PCR experiment only; ND = not detected; NA = not analyzed. Description of tissue types: TVB = Terminal Vegetative Bud, LVB = Lateral Vegetative Bud, FTV = TVB Flushed, FLVB = LVB Flushed, ST = Shoot Tip, MF = Mature/Expanded Flower, and IB = Inflorescence Bud.

**Table F 2** Relative expression (RE) of native *PtCENL-1* and *PtMFT* in different tissue types collected across a seasonal cycle. RE was re-scaled to the sample with the lowest expression, which was set to 1. ND = not detectable; NA = not analyzed.

Date	Tissue	Sample name	<i>PtCENL-1</i> ± SD	<i>PtMFT</i> ± SD
3/20/2001	TVB	R1-TVB 3/20	63.84 ± 9.59	22.28 ± 1.35
		R6-TVB 3/20	142.02 ± 15.03	20.56 ± 3.19
	LVB	R1-LVB 3/20	114.02 ± 3.30	49.76 ± 0.85
		R6-LVB 3/20	108.64 ± 9.76	37.55 ± 0.89
4/3/2001	TVB	R1-TVB 4/3	102.33 ± 7.06	16.68 ± 11.69
		R6-TVB 4/3	134.93 ± 8.16	8.57 ± 2.46
	LVB	R1-LVB 4/3	99.73 ± 8.74	28.27 ± 3.21
		R6-LVB 4/3	77.98 ± 5.36	13.49 ± 10.40
4/18/2001	FTV	R1-FTV 4/18	121.02 ± 5.99	3.98 ± 1.04
		R6-FTV 4/18	131.26 ± 2.70	3.21 ± 0.67
		R6B-FTV 4/18	226.59 ± 17.18	5.72 ± 0.85
	FLVB	R1-FLVB 4/18	284.82 ± 54.86	ND
		R6-FLVB 4/18	175.89 ± 8.32	3.17 ± 0.68

Continued

8/7/2001	TVB	R2-TV8 8/7	$68.09 \pm 2.99$	$27.44 \pm 3.00$
		R6-TV8 8/7	$132.06 \pm 9.71$	$29.78 \pm 2.01$
		R6B-TV8 8/7	$132.50 \pm 17.18$	$53.38 \pm 11.26$
	LVB	R1-LVB 8/7	$97.57 \pm 12.56$	$20.78 \pm 2.81$
		R6-LVB 8/7	$32.38 \pm 0.81$	$34.18 \pm 4.06$
5/3/2001	ST	R1-ST 5/3	$12.69 \pm 0.84$	$1.47 \pm 1.15$
		R6-ST 5/3	$48.60 \pm 4.60$	$1.00 \pm 0.73$
		R6B-ST 5/3	$26.93 \pm 2.48$	NA
6/19/2001	ST	R1-ST 6/19	$22.91 \pm 4.07$	NA
		R6-ST 6/19	$10.36 \pm 0.56$	NA
		R6B-ST 6/19	$23.42 \pm 2.48$	NA
3/20/2001	MF	R5-MF 3/20	$0.23 \pm 0.02$	$2.85 \pm 0.04$
4/3/2001		R6-MF 4/3	$2.63 \pm 0.29$	$16.10 \pm 6.05$
8/7/2001	IB	R6-IB 8/7	$7.25 \pm 0.80$	$13.29 \pm 3.36$
10/15/2001		R6-IB 10/15	$0.85 \pm 0.24$	$61.90 \pm 7.50$
10/15/2001	TVB	R1-TV8 10/15	$1.00 \pm 0.65$	NA
		R6-TV8 10/15	$1.23 \pm 0.42$	NA
		R6B-TV8 10/15	$0.97 \pm 0.63$	NA
	LVB	R1-LVB 10/15	$2.43 \pm 0.56$	$66.20 \pm 17.66$
		R6-LVB 10/15	$1.51 \pm 0.11$	$127.13 \pm 13.78$

## Appendix G MEASURING RT-PCR VARIATION IN GENE EXPRESSION WITHIN A WIDE VARIETY OF TISSUE SAMPLES

Variation in *UBQ*, *PtCENL-1*, and *PtMFT* expression detected between the tissues described in Appendix F. Data below are mean Ct values, from specific sets of tissue samples per real-time PCR run. Set = sample set (for example, sets H and J consisted different tissue types); Replicate = real-time PCR runs performed at different times, using the same sets of cDNA samples; Mean Ct = mean Ct value over duplicate PCR reactions in a real-time PCR run; and Mean Rep = mean Ct over replicates of real-time PCR runs. Coefficient of variation (CV %) = 100 (standard deviation/mean).

**Table G 1** Summary on CV calculation for measuring variation in *UBQ* expression over different tissue types.

<i>UBQ</i> in different tissue types collected at different times of the year (33 types) from poplar hybrid, clone 15-29						
Set	Replicate	Mean Ct	Mean Rep	SD	CV (%)	
H	1	23.63	23.19	0.62	2.68	
H	2	22.75				
I	1	23.89	22.77	1.59	6.99	
I	2	21.64				
J	1	22.81	22.75	0.08	0.37	
J	2	22.69				
<i>UBQ</i> in different organs (12 tissue types) collected from wild cottonwood						
Set	Replicate	Mean Ct	Mean Rep	SD	CV (%)	
N	1	20.79	20.85	0.10	0.48	
N	2	20.96				
N	3	20.90				
N	4	20.74				
	Overall Mean	23.37	22.39			
	Overall SD	1.84	1.05			
	Overall CV %	<b>7.88</b>	<b>4.68</b>			

**Table G 2** Summary on CV calculation for measuring variation in *PtCENL-1* and *PtMFT* expressions over different tissue types.

<i>PtCENL-1</i> in different tissue types collected at different times of the season (33 types)						
Set	Replicate	Mean Ct	Mean Rep	SD	CV (%)	
H	1	29.54	29.00	0.76	2.63	
H	2	28.46				
I	1	31.56	30.51	1.48	4.86	
I	2	29.46				
J	1	34.93	34.20	1.04	3.03	
J	2	33.46				
<i>PtCENL-1</i> in different organs (12 tissue types)						
Set	Replicate	Mean Ct	Mean Rep	SD	CV (%)	
N	1	30.15	30.23	0.11	0.36	
N	2	30.31				
	Overall Mean	30.99	30.99			
	Overall SD	2.20	2.24			
	Overall CV %	<b>7.11</b>	<b>7.23</b>			
<i>PtMFT</i> in different tissue types collected at different times of the season (26 types)						
Set	Replicate	Mean Ct	Mean Rep	SD	CV (%)	
K	1	34.84	34.76	0.11	0.33	
K	2	34.68				
L	1	33.45	33.37	0.12	0.35	
L	2	33.29				
M	1	35.52	35.46	0.08	0.23	
M	2	35.40				
<i>PtMFT</i> in different organs (12 tissue types)						
Set	Replicate	Mean Ct	Mean Rep	SD	CV (%)	
N	1	31.00	30.65	0.50	1.64	
N	2	30.29				
	Overall Mean	33.56	33.56			
	Overall SD	1.98	2.13			
	Overall CV %	<b>5.90</b>	<b>6.34</b>			

## Appendix H CONSTRUCT ASSEMBLY

**A) Flowchart for the assembly of the overexpression constructs, pA35SPCENL-1 and pA35SPMFT.** Coding sequence of *PtCENL-1* and *PtMFT* with the respective PCR primers (bold and underlined) used for their amplification is listed below. Thermocycler conditions were as follow: denaturation = 94 °C for 1 min; annealing = (temperature is pair specific, see below) for 1 min; extension = 72 °C for 1 min; cycles = 30.

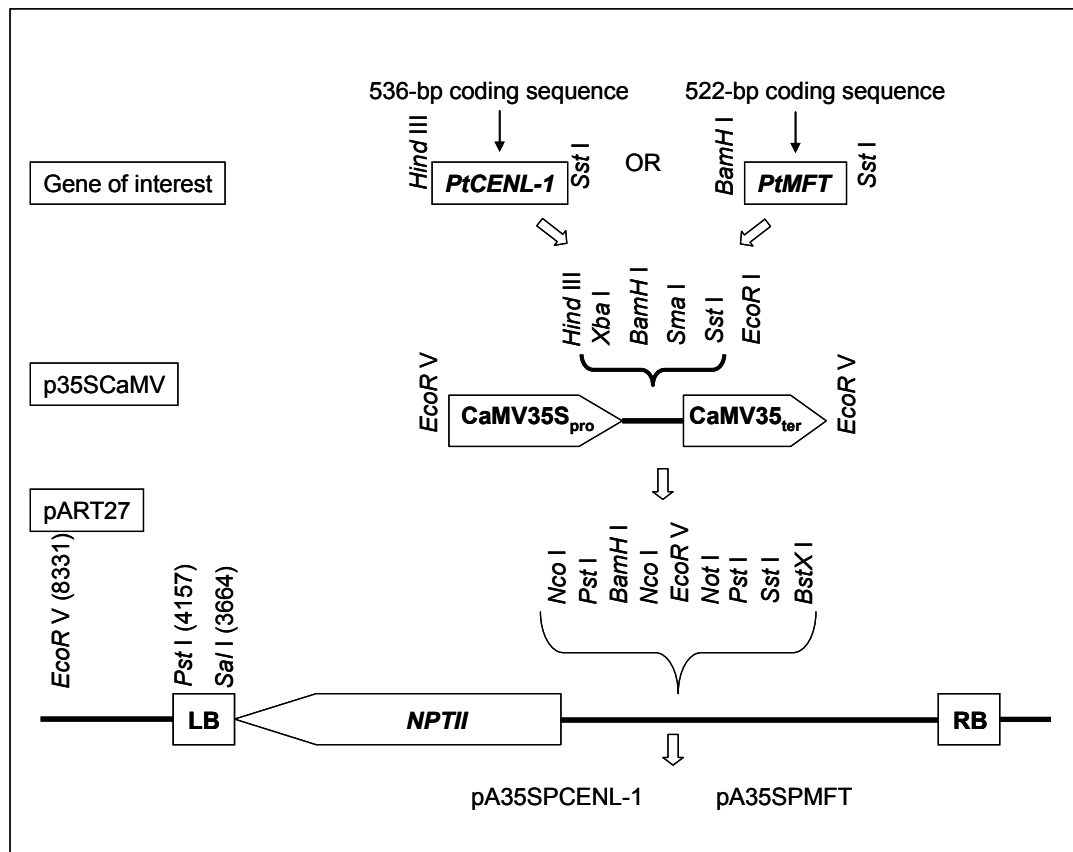

Full-length coding sequence of *PtCENL-1*

```

1  ATGGCAAAGA TGTCAGAGCC TCTTGTGGTT GGGAGAGTGA TTGGAGATGT
51 TATCGATCAT TTCACTGCAA ATGTGAAAAT GACAGTGA CT TATCAGTCCA
101 ACAGGAAGCA GGTTTTAAAT GGCCATGAGC TATTC CCATC TGCGGTA ACT
151 CATAAACCTA AAGTTGAGGT TCATGGAGGT GATATGAGAT CCTTTTTT CAC
201 CCTGGTCATG ACAGACCCTG ATGTTCCCTGG TCCTAGTGAT CCATACCTCA
251 GGGAGCACCT ACACTGGATA GTA ACTGACA TCC CAGGCAC CACAGATGCC
301 ACATTTGGAA GGG AAGTGAT GAACTATGAG ATGCCAAGGC CTAACATAGG
351 GATCCACAGG TTTGTTTTCC TACTTTTCAA GCAG AAGGGA AGGCAAACAG
401 TGACCACTCC AGCTTCAAGG GACAAATTTA ACACCAGGAA ATTTCGCTGAA
451 GAAAATGAGC TTGGCCTGCC GTAGCCGCT GTCTTCTTCA ATGCCCAAAG
501 GGAAACAGCG GCGAGGAAAC GTTGAGGAGA AGATAA

```

Forward primer with a *Hind* III site (italic and underlined) introduced at the 5' end:

PCEN001.1F = 5'-CG**AAGCTT**ATGGCAAAGATGTCA-3'; and reverse primer

with a *Sst* I site (italic and underlined) introduced at the 3' end: PCEN002.2R =

5'-TC**GAGCTC**TTATCTTCTCCTCAACGT-3'. PCR product size = 552 bp.

Annealing temperature = 63 °C for 1 min.

Full-length coding sequence of *PtMFT1*

```

1  ATGGCTGCCT CTGTTGATCC TCTTGTGGTT GGTCTGTGTTA TTGGTGATGT
51 GGTGATATG TTTGTCCCTG CTGTAAAAAT GTCTGTTTAT TATGGATCAA
101 AGCATGTTAG CAATGGGTGT GATATTAAGC CTTCTTTGTC CGTGGACCCT
151 CCCAAAGTGA CCATTCTGG CCACTCTGAC GAGCTGTACA CTCTGGTGAT
201 GACTGATCCT GATGCACCTA GCCCTAGTGA ACCCAGAATG CGAGAGTGGG
251 TTCATTGGAT CGTTGCGGAC ATTCTTGGGG GCACAAACCC TACTCGAGGG
301 AAAGAGATCC TTTCTTATGT TGGGCCTCGT CCGCCGGTGG GAATTCATCG
351 CTACATACTG GTGCTTTTCC AGCAGAAAGAT GCCGCTGGGG AGCATGGTGG
401 AACCACCGCA GAACCGTTCT CATTTCAACA CTCGACTCTA TGCTGCTCAT
451 TTGGACCTGG GCCTGCCTGT TGCCACCGTC TACTTCAATG CTCAGAAGGA
501 GCCAGCAAAT AAGAGGCGCT AA

```

Forward primer with a *Bam*H I site (italic and underlined) introduced at the 5' end:

PMFT001.1F = 5'-CT**GGATCC**ATGGCTGCCTCTGTTGA-3'; and reverse primer

with a *Sst* I site (italic and underlined) introduced at the 3' end: PMFT002.2R =

5'-CG**GAGCTC**TTAGCGCCTCTTATTTGCTG-3'. PCR product = 538 bp.

Annealing temperature = 69 °C for 1 min.

**B) Flowchart for the assembly of the RNAi constructs, pAHAN-PCENL-1 and pAHAN-PMFT.** Coding sequence of *PtCENL-1* and *PtMFT* with the respective PCR primers (underlined) used for creating both the sense and antisense arms; only with different restriction enzyme recognition sites generated at the ends.

Thermocycler conditions were as follow: denaturation = 94 °C for 1 min, annealing = (temperature is pair specific, see below) for 1 min, extension = 72 °C for 1 min, cycles = 30.

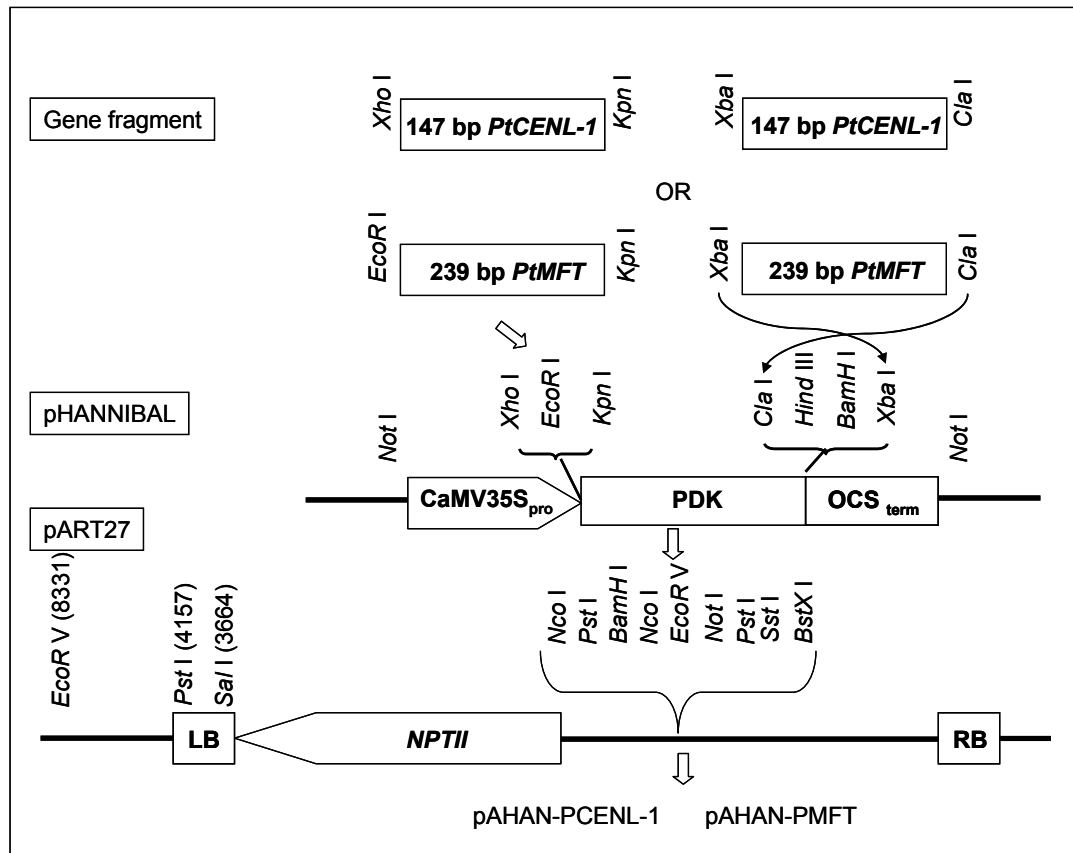

Full-length coding sequence of *PtCENL-1*

```

1  ATGGCAAAGA TGTCAAGGCC TCTTGTGGTT GGGAGAGTGA TTGGAGATGT
51  TATCGATCAT TTCACTGCAA ATGTGAAAAAT GACAGTGAAT TATCAGTCCA
101 ACAGGAAGCA GTTTTTTAAT GGCCATGAGC TATTCCCATC TGCGGTAAC
151 CATAAACCTA AAGTTGAGGT TCATGGAGGT GATATGAGAT CCTTTTTTAC
201 CCTGGTCATG ACAGACCCTG ATGTTCCCTGG TCCTAGTGAT CCATACCTCA
251 GGGAGCACCT ACACTGGATA GTAACCTGACA TCCCAGGCAC CACAGATGCC
301 ACATTTGGAA GGAAGTGAT GAACTATGAG ATGCCAAGGC CTAACATAGG
351 GATCCACAGG TTTGTTTTCC TACTTTTCAA GCAGAAGGGA AGGCAAACAG
401 TGACCACTCC AGCTTCAAGG GACAAATTTA ACACCAGGAA ATTCGCTGAA
451 GAAAATGAGC TTGGCCTGCC TGTAGCCGCT GTCTTCTTCA ATGCCCAAAG
501 GGAAACAGCG GCGAGGAAAC GTTGAGGAGA AGATAA

```

Primers for generating the sense arm were: forward primer with a *Xho* I site (italic and underlined) introduced at the 5' end (PCEN003.1F = 5'-**GACTCGAGA**AAGGCAAACAGTGACC-3'), and reverse primer with a *Kpn* I site (italic and underlined) introduced at the 3' end (PCEN004.2R = 5'-GT**GGTACCT**TATCTTCTCCTCAACGTT-3').

Primers for generating the antisense arm were: forward primer with a *Xba* I site (italic and underlined) introduced at the 5' end (PCEN005.1F = 5'-**GCTCTAGAA**AAGGCAAACAGTGACC-3'), and reverse primer with a *Cla* I site (italic and underlined) introduced at the 3' end (PCEN006.2R = 5'-GT**ATCGATT**TATCTTCTCCTCAACGTT-3').

PCR product = 163 bp. Annealing temperature = 62 °C for 1 min.

Full-length coding sequence of *PtMFT*

```

1  ATGGCTGCCT CTGTTGATCC TCTTGTGTT GGTCGTGTTA TTGGTGATGT
51 GGTGATATG TTTGTCCCTG CTGTAAAAAT GTCTGTTTAT TATGGATCAA
101 AGCATGTTAG CAATGGGTGT GATATTAAGC CTTCTTTGTC CGTGGACCCT
151 CCCAAAGTGA CCATTTCTGG CCACTCTGAC GAGCTGTACA CTCTGGTGAT
201 GACTGATCCT GATGCACCTA GCCCTAGTGA ACCCAGAATG CGAGAGTGGG
251 TTCATTGGAT CGTTGCGGAC ATTCTGGGG GCACAAAACC TACTCGAGGG
301 AAAGAGATCC TTTCTATGT TGGGCCTCGT CCGCCGGTGG GAATTCATCG
351 CTACATACTG GTGCTTTTCC AGCAGAAGAT GCCCTGGGG AGCATGGTGG
401 AACCACCGCA GAACCGTTCT CATTTCACA CTCGACTCTA TGCTGCTCAT
451 TTGGACCTGG GCCTGCCTGT TGCCACCGTC TACTTCAATG CTCAGAAGGA
501 GCCAGCAAAT AAGAGGCGCT AA

```

Primers for generating the sense arm were: forward primer with an *EcoR* I site (italic and underlined) introduced at the 5' end (PMFT003.1F = 5'-GT*GAATTC*ATGGCTGCCTCTGTTGATC-3'), and reverse primer with a *Kpn* I site (italic) introduced at the 3' end (PMFT004.2R = 5'-GT*GGTACC*ATTCTGGGTTCACTAGGGCT-3').

PCR product = 255 bp. Annealing temperature = 68 °C for 1 min.

Primers for generating the antisense arm were: forward primer with a *Xba* I site (italic) introduced at the 5' end (PMFT005.1F = 5'-GT*TCTAGA*ATGGCTGCCTCTGTTGATC-3'), and reverse primer with a *Cla* I site (italic) introduced at the 3' end (PMFT006.2R = 5'-GT*ATCGAT*ATTCTGGGTTCACTAGGGCT-3').

PCR product = 255 bp. Annealing temperature = 63 °C for 1 min.

## Appendix I TRANSGENE DETECTION VIA PCR ANALYSIS

Transformed plants were regenerated in tissue culture for 2-3 months before the young shoot and leaflets were collected for genomic DNA preparation using a small-scale DNA preparation protocol (<http://zircote.forestry.oregonstate.edu/tgbb/protocols/dnaext.htm>, Bradshaw and Stettler 1993). Thermocycler conditions were as follow: denaturation = 94 °C for 1 min; annealing = (temperature is pair specific, see below) for 1 min; extension = 72 °C for 1 min; cycles = 30.

### A) Transgenic poplar transformed with the overexpression constructs expressing *PtCENL-1* or *PtMFT*

Gene-specific primers were directed to border sequences of CaMV 35S cassette (<http://www.pgreen.ac.uk/JIT/35S-2.txt>).

Forward: 35S002.1F = 5'-GCACAATCCCCTATCCTTC-3'

Reverse: 35S003.2R = 5'-AGATTTGTAGAGAGAGACTGGTGA-3'

Amplification product = 698 bp (for *PtCENL-1*) and 684 bp (for *PtMFT*)

Annealing temperature = 57 °C for 1 min.

### B) Transgenic poplar transformed with the RNAi constructs for the suppression of *PtCENL-1* or *PtMFT*

Gene-specific primers were directed to sequences bordering the sense sequence (between CaMV 35S promoter and PDK intron) and the antisense sequence (PDK intron and OCS terminator) based on the pHANNIBAL sequence (EMBL database: AJ311872).

Forward (sense): 35S001.1F = 5'-TTCCAACCACGTCTTCAAAG-3'

Reverse (sense): PDK001.2R = 5'-CTTCTTCGTCTTACACATCACTTG-3'

Amplification product = 500 bp (for *PtCENL-1*) and 592 bp (for *PtMFT*)

Annealing temperature = 57 °C for 1 min.

Forward (antisense): PDK002.1F = 5'-AGTCGAACATGAATAAACAAGGT-3'

Reverse (antisense): OCS001.2R = 5'-GTAAGGATCTGAGCTACACATGC-3'

Amplification product = 394 bp (for *PtCENL-1*) and 486 bp (for *PtMFT*)

Annealing temperature = 57 °C for 1 min.

## Appendix J SMALL-SCALE DNA EXTRACTION PROTOCOL FOR POPLAR

This quick small-scale protocol was developed at the Forest Tree Biotechnology lab at Oregon State University, Corvallis, OR, USA, and is available at <http://zircote.forestry.oregonstate.edu/tgbb/protocols/dnaext.htm>. This method is derived from a procedure developed by Dr. Toby Bradshaw and the Poplar Molecular Genetics Cooperative. We have tested the procedure with a variety of *Populus* species, as well as tobacco and *Arabidopsis*. The resulting DNA is of sufficiently high quality for PCR (including RAPD), restriction digests, and ligation reactions. However, it is extremely important to use the youngest leaves available for *Populus*, as DNA from older leaves is often contaminated with compounds that can interfere with enzymatic reactions. Expected yield is 5-30 ug, depending on the quality and quantity of the foliage. Yields can be increased beyond 30 ug by using multiple young leaves and increasing the volumes of the grinding and extraction buffers.

### Steps

1. Add diethyl dithiocarbamic acid, sodium salt (4 mg/ml) and RNAase A (100 µg/ml) to an aliquot of Grinding Buffer, and β-mercaptoethanol (1%) to an aliquot of Lysis Buffer (see below).
2. Use a single newly emerged, rolled leaf (~10 mg, the newer the better). Place foliage in microfuge tubes in a liquid nitrogen bath.
3. Add approximately 200 to 400 µl of liquid nitrogen to a tube containing foliage. Grind approx. 10-15 seconds using a motorized pestle. Stop grinding when liquid nitrogen evaporates and tissue defrosts.
4. Add 200 µl Grinding Buffer. Grind another 10 seconds until tissue is well-homogenized.
5. Place tube in water bath (~ 40-65 °C) and incubate while grinding other samples. Each sample should be incubated at least 10 min.
6. Add 200 µl Lysis Buffer to each tube. Mix by inverting several times.
7. After grinding all samples (typically as many as will fit in microfuge), incubate at 65 °C for 30-60 min. Every 10 to 15 minutes, mix by inverting tubes several times.
8. Add equal volume of phenol:chloroform:isoamyl alcohol (25:24:1). Mix well by inverting at least 10 times. Spin 8-10 min at 12,000 rpm at room temperature using a microfuge.

9. Remove 50-70% of supernatant to new tube, taking care to avoid interface. If supernatant is cloudy or contaminated with interface, go to step 10. Otherwise skip to 12.
10. (Optional) Add an equal volume of chloroform, mix well by inverting at least 10 times. Spin 5 min at 12,000 rpm at room temperature.
11. Remove 50-70% of supernatant to new tube, taking care to avoid interface.
12. Add 2/3 volume of isopropanol. Mix by inverting.
13. Incubate 15-30 min on ice or room temperature.
14. Spin in microfuge 5-10 min at room temperature.
15. Decant supernatant and blot tubes on paper towels.
16. Dry in Speed-Vac for 2-4 min until no isopropanol odor is apparent.
17. Add 50  $\mu$ l TE buffer (10:1), pH 8. Let sit at room temperature for 10-20 min, or at 4  $^{\circ}$ C overnight (preferred). Mix by flicking tube several times.

## **Solutions**

### Grinding Buffer

- 100 mM Tris, pH 8
- 20 mM EDTA, pH 8
- 4 mg/ml diethyl dithiocarbamic acid, sodium salt, added just prior to use
- 100  $\mu$ g/ml RNAase A, added just prior to use

### Lysis Buffer

- 100 mM Tris, pH 8
- 20 mM EDTA, pH 8
- 1 M NaCl
- 2% SDS
- 1%  $\beta$ -mercaptoethanol, added just prior to use

## Appendix K PHENOTYPIC AND EXPRESSION DATA OF TRANSGENIC *ARABIDOPSIS* PLANTS

All transgenic *Arabidopsis* (ecotype Columbia) plants were selected on kanamycin-containing media and transferred into soil and grown under long days (16-hr light) in a growth chamber at 22 °C. ‘Days to flowering’ and ‘Number of rosette leaves’ were recorded when the primary inflorescence bolted and reached 1 cm above soil level. Differences between transgenic and non-transgenic means were tested using the Student’s *t*-test (SAS, version 9.1, SAS Institute Inc., 2002-2003).

**Table K 1** Mean and standard deviation (SD) of flowering time and number of rosette leaves in transgenic and wild-type *Arabidopsis*.

Construct	Days to flowering time $\pm$ SD	Number of rosette leaves $\pm$ SD	Number of plants
35S:: <i>PtMFT</i>	16.50 $\pm$ 4.30	8.38 $\pm$ 1.35	24
35S:: <i>PtCENL-1</i> (flowering group)	16.04 $\pm$ 3.50	10.14 $\pm$ 5.54	23
35S:: <i>PtCENL-1</i> (late/non-flowering group)	50.6 $\pm$ 9.02	40.8 $\pm$ 6.76	5
Wild-type (WT)	25.91 $\pm$ 5.72	12.18 $\pm$ 4.15	22

### *t*-test

1) Comparing means for *Days to flowering* between transgenic and control groups. Output from the *t*-test is shown below. Class TYPE: 1 = 35S::*PtMFT* and 2 = WT.

TYPE	N	Mean	SD	SE
1	24	16.5	4.30	0.88
2	22	25.9	5.72	1.22

Variances	T	Method	DF	Prob> T
Equal	-6.34	Pooled	44	<b>0.0001</b>

The *t*-test, under the assumption of equal variance, showed that the mean *Days to flowering* for 35S::*PtMFT* and WT was significantly different ( $p < 0.0001$ ).

2) Comparing means for *Number of rosette leaves* between transgenic and control groups. Output from the *t*-test is shown below. Class TYPE: 1 = 35S::*PtMFT*, and 2 = WT.

TYPE	N	Mean	SD	SE
1	24	8.38	1.35	0.27
2	22	12.18	4.15	0.88
Variances	T	Method	DF	Prob> T
Equal	-4.26	Pooled	44	<b>0.0001</b>

The *t*-test, under the assumptions of equal variance, showed that the mean *Number of rosette leaves* for 35S::*PtMFT* and WT was significantly different ( $p < 0.0001$ ).

3) Comparing means for *Days to flowering* between 35S::*PtCENL-1* transgenic groups. Output from the *t*-test is shown below. Class TYPE: 1 = flowering 35S::*PtCENL-1*, and 2 = late/non-flowering 35S::*PtCENL-1*.

TYPE	N	Mean	SD	SE
1	23	16.0	3.50	0.73
2	5	50.6	9.02	4.03
Variances	T	Method	DF	Prob> T
Equal	-14.65	Pooled	26	<b>&lt;0.0001</b>

The *t*-test, under the assumption of equal variance, showed that the mean *Days to flowering* for the flowering 35S::*PtCENL-1* and the late/non-flowering 35S::*PtCENL-1* groups was significantly different ( $p < 0.0001$ ).

4) Comparing means for *Number of rosette leaves* between 35S::*PtCENL-1* transgenic groups. Output from the *t*-test is shown below. Class TYPE: 1 = flowering 35S::*PtCENL-1*, and 2 = late/non-flowering 35S::*PtCENL-1*.

TYPE	N	Mean	SD	SE
1	21	10.14	5.54	1.21
2	5	40.4	6.76	3.02
Variiances	T	Method	DF	Prob> T
Equal	-4.26	Pooled	44	< <b>0.0001</b>

The *t*-test, under the assumptions of equal variance, showed that the mean *Number of rosette leaves* for the flowering 35S::*PtCENL-1* and the late/non-flowering 35S::*PtCENL-1* groups was significantly different ( $p < 0.0001$ ).

**Table K 2** Relative expression (RE) and standard deviation (SD) of transgenes in representative transgenic events selected based on time of flowering. RE was determined via real-time PCR from 0.2  $\mu$ g of total RNA as described in Materials and Methods, Chapter 3. For rescaling purposes, RE of the transgenic plant with the lowest expression was set to 1.

<i>Arabidopsis</i> transgenic plants	Transgene	Relative expression of transgene $\pm$ SD	Days to flowering
DFT-25	<i>PtMFT</i>	64.019 $\pm$ 2.20	10
DFT-20	<i>PtMFT</i>	51.58 $\pm$ 5.30	13
DFT-19	<i>PtMFT</i>	55.53 $\pm$ 1.36	13
DFT-24	<i>PtMFT</i>	24.17 $\pm$ 1.95	16
DFT-33	<i>PtMFT</i>	7.97 $\pm$ 2.42	17
DFT-27	<i>PtMFT</i>	49.21 $\pm$ 14.27	17
DFT-40	<i>PtMFT</i>	31.42 $\pm$ 1.77	21
DFT-38	<i>PtMFT</i>	17.53 $\pm$ 2.40	24
DFT-32	<i>PtMFT</i>	1	27
DPC-A5	<i>PtCENL-1</i>	16.51 $\pm$ 0.65	13
DPC-A8	<i>PtCENL-1</i>	1	13
DPC-A9	<i>PtCENL-1</i>	1.78 $\pm$ 0.13	13
DPC-B1	<i>PtCENL-1</i>	27.15 $\pm$ 1.13	18
DPC-B6	<i>PtCENL-1</i>	23.55 $\pm$ 0.06	18
DPC-B3	<i>PtCENL-1</i>	20.32 $\pm$ 2.93	19
DPC-B22	<i>PtCENL-1</i>	3.57 $\pm$ 0.31	22
DPC-C29	<i>PtCENL-1</i>	53.59 $\pm$ 5.51	40
DPC-C14	<i>PtCENL-1</i>	99.05 $\pm$ 1.94	46
DPC-C8	<i>PtCENL-1</i>	136.25 $\pm$ 2.67	59
DPC-C7	<i>PtCENL-1</i>	202.60 $\pm$ 0.50	61

## Appendix L LIST OF POPLAR TRANSGENICS

All transgenic plants were derived from hybrid 717-1B4 (*P. tremula* x *P. alba*, INRA France). They were all resistant to kanamycin and PCR positive for their respective constructs.

<b>35S::PtMFT</b>	<b>HANNIBAL::PtMFT</b>	<b>35S::PtCENL-1</b>	<b>HANNIBAL::PtCENL-1</b>
1	5	1	6
7	32	3	7
8	34	6	14
19	40	21	20
36	62	29	27
37	86	32	35
61	96	36	36
74	111	37	153
76	124	38	169
93	127	43	175
98	129	45	178
103	131	46	179
111	136	47	183
113	137	64	190
125	153	67	191
127		70	
131		80	
149		113	
150		124	
<b>Total = 19</b>	<b>Total = 15</b>	<b>Total = 19</b>	<b>Total = 15</b>

**Appendix M CHARACTERIZATION OF TRANSGENIC POPLARS: GROWTH ASSESSMENT, TIMING OF BUDFLUSH, AND RELATIVE EXPRESSION OF TARGET GENES**

**A) Growth assessment and timing of budflush**

Growth data was obtained by taking the height and the diameter of trees over one growing season, and budflush was scored in Julian date, as described in Materials and Methods, Chapter 3. Group means are in natural logarithmic (ln) values.

**Table M 1** Mean (natural logarithm) and standard error (SE) of the timing of budflush and tree growth for non-transgenic control and transgenic trees.

<b>Construct</b>	<b>Budflush (Julian date)</b>	<b>Net growth (Volume index)</b>
	<b>Mean ± SE</b>	<b>Mean ± SE</b>
Control (non-transgenic)	4.564 ± 0.012	4.07 ± 0.24
HANNIBAL:: <i>PtCEN-1</i>	4.594 ± 0.005	4.13 ± 0.10
HANNIBAL:: <i>PtMFT</i>	4.577 ± 0.005	3.99 ± 0.10
35S:: <i>PtCENL-1</i>	4.655 ± 0.005	3.56 ± 0.09
35S:: <i>PtMFT</i>	4.622 ± 0.004	4.10 ± 0.09

**Table M 2** Mean and standard error (SE) of the timing of budflush and tree growth for non-transgenic control and transgenic trees.

<b>Construct</b>	<b>Budflush (Julian date)</b>	<b>Net growth (cm<sup>2</sup>)</b>
	<b>Mean ± SE</b>	<b>Mean ± SE</b>
Control (non-transgenic)	95.97 ± 1.01	58.43 ± 1.27
HANNIBAL:: <i>PtCEN-1</i>	98.88 ± 1.00	61.99 ± 1.10
HANNIBAL:: <i>PtMFT</i>	97.18 ± 1.01	54.24 ± 1.10
35S:: <i>PtCENL-1</i>	105.10 ± 1.00	35.08 ± 1.09
35S:: <i>PtMFT</i>	101.66 ± 1.00	60.61 ± 1.09

## Statistical analysis

Analysis on growth and budflush were performed using the MIXED procedure, SAS (version 9.1, SAS Institute Inc., 2002-2003). Output is shown below. Data analyzed were the average of four ramets for each transgenic event, and ten ramets for control trees, after transformation by taking the natural logarithm.

### Budflush data

#### *Tests of fixed effects*

Source	NDF	DDF	Type III F	Pr > F
Construct	4	70	42.61	< 0.0001
Event (construct)	63	70	5.60	< 0.0001

#### *Differences of least-squares means (at a significance level of 0.05)*

For the effect of construct, comparisons are between construct 1 (column 3) to construct 2 (column 5). For the effect of event within construct, comparisons are between transgenic events (columns 2 and 3) against control (columns 4 and 5).

Cons 1/CT = non-transgenic control

Cons 2/HC = HANNIBAL::*PtCEN-1*

Cons 3/HF = HANNIBAL::*PtMFT*

Cons 4/PC = 35S::*PtCENL-1*

Cons 5/PM = 35S::*PtMFT*

Comparisons with significance differences are shown in **bold**.

1	2	3	4	5	6	7	8	9	10	11
Effect	Event	Cons	Event	Cons	Diff	SE	DF	t	Adjustment	Adj P
Cons		1		2	-0.02981	0.01330	70	-2.24	Tukey-Kramer	0.1771
Cons		1		3	-0.01251	0.01324	70	-0.95	Tukey-Kramer	0.8782
<b>Cons</b>		<b>1</b>		<b>4</b>	<b>-0.09082</b>	<b>0.01308</b>	<b>70</b>	<b>-6.94</b>	<b>Tukey-Kramer</b>	<b>&lt;.0001</b>
<b>Cons</b>		<b>1</b>		<b>5</b>	<b>-0.05756</b>	<b>0.01304</b>	<b>70</b>	<b>-4.41</b>	<b>Tukey-Kramer</b>	<b>0.0003</b>
Cons		2		3	0.01729	0.007193	70	2.40	Tukey-Kramer	0.1263
<b>Cons</b>		<b>2</b>		<b>4</b>	<b>-0.06101</b>	<b>0.006897</b>	<b>70</b>	<b>-8.85</b>	<b>Tukey-Kramer</b>	<b>&lt;.0001</b>
<b>Cons</b>		<b>2</b>		<b>5</b>	<b>-0.02775</b>	<b>0.006817</b>	<b>70</b>	<b>-4.07</b>	<b>Tukey-Kramer</b>	<b>0.0011</b>
<b>Cons</b>		<b>3</b>		<b>4</b>	<b>-0.07830</b>	<b>0.006775</b>	<b>70</b>	<b>-11.56</b>	<b>Tukey-Kramer</b>	<b>&lt;.0001</b>
<b>Cons</b>		<b>3</b>		<b>5</b>	<b>-0.04504</b>	<b>0.006693</b>	<b>70</b>	<b>-6.73</b>	<b>Tukey-Kramer</b>	<b>&lt;.0001</b>
<b>Cons</b>		<b>4</b>		<b>5</b>	<b>0.03326</b>	<b>0.006374</b>	<b>70</b>	<b>5.22</b>	<b>Tukey-Kramer</b>	<b>&lt;.0001</b>
Event (Cons)	HC14	2	CT	1	0.02420	0.02293	70	1.06	Dunnett	1.0000
Event (Cons)	HC153	2	CT	1	0.007862	0.02293	70	0.34	Dunnett	1.0000
Event (Cons)	HC169	2	CT	1	0.05093	0.02293	70	2.22	Dunnett	0.6780
Event (Cons)	HC175	2	CT	1	0.04112	0.02293	70	1.79	Dunnett	0.9448
Event (Cons)	HC178	2	CT	1	0.02589	0.02293	70	1.13	Dunnett	1.0000
Event (Cons)	HC179	2	CT	1	0.03570	0.02293	70	1.56	Dunnett	0.9918
Event (Cons)	HC183	2	CT	1	0.04112	0.02293	70	1.79	Dunnett	0.9448
Event (Cons)	HC190	2	CT	1	0.01828	0.02293	70	0.80	Dunnett	1.0000
Event (Cons)	HC191	2	CT	1	0.05804	0.02293	70	2.53	Dunnett	0.4267
Event (Cons)	HC20	2	CT	1	0.007862	0.02293	70	0.34	Dunnett	1.0000
<b>Event (Cons)</b>	<b>HC27</b>	<b>2</b>	<b>CT</b>	<b>1</b>	<b>0.08369</b>	<b>0.02293</b>	<b>70</b>	<b>3.65</b>	<b>Dunnett</b>	<b>0.0274</b>
Event (Cons)	HC35	2	CT	1	0.03846	0.02293	70	1.68	Dunnett	0.9757
Event (Cons)	HC36	2	CT	1	0.000247	0.03002	70	0.01	Dunnett	1.0000
Event (Cons)	HC6	2	CT	1	0.03461	0.02293	70	1.51	Dunnett	0.9951
Event (Cons)	HC7	2	CT	1	-0.02092	0.02293	70	-0.91	Dunnett	1.0000
Event (Cons)	HF111	3	CT	1	0.05126	0.02293	70	2.24	Dunnett	0.6660
Event (Cons)	HF124	3	CT	1	0.01828	0.02293	70	0.80	Dunnett	1.0000
Event (Cons)	HF127	3	CT	1	-0.00591	0.02293	70	-0.26	Dunnett	1.0000
Event (Cons)	HF129	3	CT	1	0.02589	0.02293	70	1.13	Dunnett	1.0000
Event (Cons)	HF131	3	CT	1	0.02830	0.02293	70	1.23	Dunnett	0.9999
Event (Cons)	HF136	3	CT	1	0.007862	0.02293	70	0.34	Dunnett	1.0000
Event (Cons)	HF137	3	CT	1	-0.01560	0.02293	70	-0.68	Dunnett	1.0000
Event (Cons)	HF153	3	CT	1	0.01537	0.02293	70	0.67	Dunnett	1.0000
Event (Cons)	HF32	3	CT	1	0.002542	0.02293	70	0.11	Dunnett	1.0000
Event (Cons)	HF34	3	CT	1	0.03871	0.02293	70	1.69	Dunnett	0.9735
Event (Cons)	HF40	3	CT	1	0.03580	0.02293	70	1.56	Dunnett	0.9915
Event (Cons)	HF5	3	CT	1	-0.01028	0.02293	70	-0.45	Dunnett	1.0000
Event (Cons)	HF62	3	CT	1	-0.00117	0.02293	70	-0.05	Dunnett	1.0000
Event (Cons)	HF86	3	CT	1	0.01756	0.02293	70	0.77	Dunnett	1.0000
Event (Cons)	HF96	3	CT	1	-0.02092	0.02293	70	-0.91	Dunnett	1.0000
Event (Cons)	PC1	4	CT	1	-0.04784	0.02293	70	-2.09	Dunnett	0.7832
Event (Cons)	PC113	4	CT	1	0.04112	0.02293	70	1.79	Dunnett	0.9448
<b>Event (Cons)</b>	<b>PC124</b>	<b>4</b>	<b>CT</b>	<b>1</b>	<b>0.2060</b>	<b>0.02293</b>	<b>70</b>	<b>8.99</b>	<b>Dunnett</b>	<b>&lt;.0001</b>
<b>Event (Cons)</b>	<b>PC21</b>	<b>4</b>	<b>CT</b>	<b>1</b>	<b>0.1675</b>	<b>0.02293</b>	<b>70</b>	<b>7.31</b>	<b>Dunnett</b>	<b>&lt;.0001</b>
<b>Event (Cons)</b>	<b>PC29</b>	<b>4</b>	<b>CT</b>	<b>1</b>	<b>0.1318</b>	<b>0.02293</b>	<b>70</b>	<b>5.75</b>	<b>Dunnett</b>	<b>&lt;.0001</b>
Event (Cons)	PC3	4	CT	1	-0.00496	0.02293	70	-0.22	Dunnett	1.0000
<b>Event (Cons)</b>	<b>PC32</b>	<b>4</b>	<b>CT</b>	<b>1</b>	<b>0.08146</b>	<b>0.02293</b>	<b>70</b>	<b>3.55</b>	<b>Dunnett</b>	<b>0.0365</b>
<b>Event (Cons)</b>	<b>PC36</b>	<b>4</b>	<b>CT</b>	<b>1</b>	<b>0.1522</b>	<b>0.02293</b>	<b>70</b>	<b>6.64</b>	<b>Dunnett</b>	<b>&lt;.0001</b>
Event (Cons)	PC37	4	CT	1	0.03351	0.02293	70	1.46	Dunnett	0.9972
Event (Cons)	PC38	4	CT	1	0.07063	0.02293	70	3.08	Dunnett	0.1315
Event (Cons)	PC43	4	CT	1	0.01828	0.02293	70	0.80	Dunnett	1.0000
Event (Cons)	PC45	4	CT	1	0.06734	0.02293	70	2.94	Dunnett	0.1857
<b>Event (Cons)</b>	<b>PC46</b>	<b>4</b>	<b>CT</b>	<b>1</b>	<b>0.1588</b>	<b>0.02293</b>	<b>70</b>	<b>6.93</b>	<b>Dunnett</b>	<b>&lt;.0001</b>
<b>Event (Cons)</b>	<b>PC47</b>	<b>4</b>	<b>CT</b>	<b>1</b>	<b>0.2080</b>	<b>0.02293</b>	<b>70</b>	<b>9.07</b>	<b>Dunnett</b>	<b>&lt;.0001</b>
Event (Cons)	PC6	4	CT	1	0.05439	0.02293	70	2.37	Dunnett	0.5528
<b>Event (Cons)</b>	<b>PC64</b>	<b>4</b>	<b>CT</b>	<b>1</b>	<b>0.1852</b>	<b>0.02293</b>	<b>70</b>	<b>8.08</b>	<b>Dunnett</b>	<b>&lt;.0001</b>
Event (Cons)	PC70	4	CT	1	0.07279	0.02293	70	3.17	Dunnett	0.1037
Event (Cons)	PC80	4	CT	1	0.03846	0.02293	70	1.68	Dunnett	0.9757
Event (Cons)	PM1	5	CT	1	0.07054	0.02293	70	3.08	Dunnett	0.1329
Event (Cons)	PM103	5	CT	1	0.04112	0.02293	70	1.79	Dunnett	0.9448

Event (Cons)	PM111	5	CT	1	0.05588	0.02293	70	2.44	Dunnett	0.4999
Event (Cons)	PM113	5	CT	1	0.05102	0.02293	70	2.23	Dunnett	0.6745
<b>Event (Cons)</b>	<b>PM125</b>	<b>5</b>	<b>CT</b>	<b>1</b>	<b>0.09456</b>	<b>0.02293</b>	<b>70</b>	<b>4.12</b>	<b>Dunnett</b>	<b>0.0060</b>
Event (Cons)	PM127	5	CT	1	0.005456	0.02293	70	0.24	Dunnett	1.0000
Event (Cons)	PM131	5	CT	1	0.03811	0.02293	70	1.66	Dunnett	0.9786
Event (Cons)	PM149	5	CT	1	0.06073	0.02293	70	2.65	Dunnett	0.3433
Event (Cons)	PM150	5	CT	1	0.02808	0.02293	70	1.22	Dunnett	0.9999
<b>Event (Cons)</b>	<b>PM19</b>	<b>5</b>	<b>CT</b>	<b>1</b>	<b>0.1037</b>	<b>0.02293</b>	<b>70</b>	<b>4.52</b>	<b>Dunnett</b>	<b>0.0015</b>
Event (Cons)	PM36	5	CT	1	0.05588	0.02293	70	2.44	Dunnett	0.4999
Event (Cons)	PM37	5	CT	1	0.02589	0.02293	70	1.13	Dunnett	1.0000
<b>Event (Cons)</b>	<b>PM61</b>	<b>5</b>	<b>CT</b>	<b>1</b>	<b>0.1296</b>	<b>0.02293</b>	<b>70</b>	<b>5.65</b>	<b>Dunnett</b>	<b>&lt;.0001</b>
<b>Event (Cons)</b>	<b>PM7</b>	<b>5</b>	<b>CT</b>	<b>1</b>	<b>0.1175</b>	<b>0.02293</b>	<b>70</b>	<b>5.13</b>	<b>Dunnett</b>	<b>0.0002</b>
Event (Cons)	PM74	5	CT	1	0.03351	0.02293	70	1.46	Dunnett	0.9972
Event (Cons)	PM76	5	CT	1	0.02830	0.02293	70	1.23	Dunnett	0.9999
Event (Cons)	PM8	5	CT	1	0.06083	0.02293	70	2.65	Dunnett	0.3405
Event (Cons)	PM93	5	CT	1	0.07216	0.02293	70	3.15	Dunnett	0.1112
Event (Cons)	PM98	5	CT	1	0.02069	0.02293	70	0.90	Dunnett	1.0000

## Growth data

### *Tests of fixed effects*

Source	NDF	DDF	Type III F	Pr > F
Construct	4	71	6.94	<.0001
Event (Construct)	64	71	2.61	<.0001

### *Differences of least-squares means (at a significance level of 0.05)*

For the effect of construct, comparisons are between construct 1 (column 3) to construct 2 (column 5). For the effect of event within construct, comparisons are between transgenic events (columns 2 and 3) against control (columns 4 and 5).

Cons 1/CT = non-transgenic control

Cons 2/HC = HANNIBAL::*PtCEN-1*

Cons 3/HF = HANNIBAL::*PtMFT*

Cons 4/PC = 35S::*PtCENL-1*

Cons 5/PM = 35S::*PtMFT*

Comparisons with significance differences are shown in **bold**.

1	2	3	4	5	6	7	8	9	10	11
Effect	Event	Cons	Event	Cons	Diff	SE	DF	t	Adjustment	Adj P
Cons		1		2	-0.05911	0.2562	71	-0.23	Tukey-Kramer	0.9994
Cons		1		3	0.07442	0.2550	71	0.29	Tukey-Kramer	0.9984
Cons		1		4	0.5103	0.2511	71	2.03	Tukey-Kramer	0.2616
Cons		1		5	-0.03653	0.2511	71	-0.15	Tukey-Kramer	0.9999
Cons		2		3	0.1335	0.1385	71	0.96	Tukey-Kramer	0.8704
<b>Cons</b>		<b>2</b>		<b>4</b>	<b>0.5694</b>	<b>0.1313</b>	<b>71</b>	<b>4.34</b>	<b>Tukey-Kramer</b>	<b>0.0004</b>
Cons		2		5	0.02257	0.1313	71	0.17	Tukey-Kramer	0.9998
<b>Cons</b>		<b>3</b>		<b>4</b>	<b>0.4359</b>	<b>0.1289</b>	<b>71</b>	<b>3.38</b>	<b>Tukey-Kramer</b>	<b>0.0100</b>
Cons		3		5	-0.1110	0.1289	71	-0.86	Tukey-Kramer	0.9102
<b>Cons</b>		<b>4</b>		<b>5</b>	<b>-0.5468</b>	<b>0.1211</b>	<b>71</b>	<b>-4.52</b>	<b>Tukey-Kramer</b>	<b>0.0002</b>
Event (Cons)	HC14	2	CT	1	-0.4234	0.4416	71	-0.96	Dunnett	1.0000
Event (Cons)	HC153	2	CT	1	0.5135	0.4416	71	1.16	Dunnett	1.0000
Event (Cons)	HC169	2	CT	1	-0.05769	0.4416	71	-0.13	Dunnett	1.0000
Event (Cons)	HC175	2	CT	1	-0.06303	0.4416	71	-0.14	Dunnett	1.0000
Event (Cons)	HC178	2	CT	1	0.5406	0.4416	71	1.22	Dunnett	0.9999
Event (Cons)	HC179	2	CT	1	-0.00677	0.4416	71	-0.02	Dunnett	1.0000
Event (Cons)	HC183	2	CT	1	0.2388	0.4416	71	0.54	Dunnett	1.0000
Event (Cons)	HC190	2	CT	1	0.8519	0.4416	71	1.93	Dunnett	0.8875
Event (Cons)	HC191	2	CT	1	0.1320	0.4416	71	0.30	Dunnett	1.0000
Event (Cons)	HC20	2	CT	1	-0.05948	0.4416	71	-0.13	Dunnett	1.0000
Event (Cons)	HC27	2	CT	1	-0.4455	0.4416	71	-1.01	Dunnett	1.0000
Event (Cons)	HC35	2	CT	1	-0.5808	0.4416	71	-1.32	Dunnett	0.9997
Event (Cons)	HC36	2	CT	1	-0.2232	0.5783	71	-0.39	Dunnett	1.0000
Event (Cons)	HC6	2	CT	1	-0.2182	0.4416	71	-0.49	Dunnett	1.0000
Event (Cons)	HC7	2	CT	1	0.6880	0.4416	71	1.56	Dunnett	0.9922
Event (Cons)	HF111	3	CT	1	-0.2764	0.4416	71	-0.63	Dunnett	1.0000
Event (Cons)	HF124	3	CT	1	0.3217	0.4416	71	0.73	Dunnett	1.0000
Event (Cons)	HF127	3	CT	1	0.5112	0.4416	71	1.16	Dunnett	1.0000
Event (Cons)	HF129	3	CT	1	0.2139	0.4416	71	0.48	Dunnett	1.0000
Event (Cons)	HF131	3	CT	1	-0.08101	0.4416	71	-0.18	Dunnett	1.0000
Event (Cons)	HF136	3	CT	1	-0.1312	0.4416	71	-0.30	Dunnett	1.0000
Event (Cons)	HF137	3	CT	1	0.1689	0.4416	71	0.38	Dunnett	1.0000
Event (Cons)	HF153	3	CT	1	-0.3566	0.4416	71	-0.81	Dunnett	1.0000
Event (Cons)	HF32	3	CT	1	-0.3526	0.4416	71	-0.80	Dunnett	1.0000
Event (Cons)	HF34	3	CT	1	-0.3502	0.4416	71	-0.79	Dunnett	1.0000
Event (Cons)	HF40	3	CT	1	0.3647	0.4416	71	0.83	Dunnett	1.0000
Event (Cons)	HF5	3	CT	1	-0.2695	0.4416	71	-0.61	Dunnett	1.0000
Event (Cons)	HF62	3	CT	1	-0.3680	0.4416	71	-0.83	Dunnett	1.0000
Event (Cons)	HF86	3	CT	1	-0.7474	0.4416	71	-1.69	Dunnett	0.9738
Event (Cons)	HF96	3	CT	1	0.2362	0.4416	71	0.53	Dunnett	1.0000
Event (Cons)	PC1	4	CT	1	-0.3628	0.4416	71	-0.82	Dunnett	1.0000
Event (Cons)	PC113	4	CT	1	0.03525	0.4416	71	0.08	Dunnett	1.0000
Event (Cons)	PC124	4	CT	1	-1.2382	0.4416	71	-2.80	Dunnett	0.2521
Event (Cons)	PC21	4	CT	1	-1.2722	0.4416	71	-2.88	Dunnett	0.2128
Event (Cons)	PC29	4	CT	1	-0.9463	0.4416	71	-2.14	Dunnett	0.7445
Event (Cons)	PC3	4	CT	1	-0.7723	0.4416	71	-1.75	Dunnett	0.9604
Event (Cons)	PC32	4	CT	1	-0.5749	0.4416	71	-1.30	Dunnett	0.9998
Event (Cons)	PC36	4	CT	1	-0.4253	0.4416	71	-0.96	Dunnett	1.0000
Event (Cons)	PC37	4	CT	1	-0.4294	0.4416	71	-0.97	Dunnett	1.0000
Event (Cons)	PC38	4	CT	1	-0.5232	0.4416	71	-1.18	Dunnett	1.0000
Event (Cons)	PC43	4	CT	1	0.08638	0.4416	71	0.20	Dunnett	1.0000
Event (Cons)	PC45	4	CT	1	0.3149	0.4416	71	0.71	Dunnett	1.0000
Event (Cons)	PC46	4	CT	1	-0.7888	0.4416	71	-1.79	Dunnett	0.9491
Event (Cons)	PC47	4	CT	1	0.1573	0.4416	71	0.36	Dunnett	1.0000
Event (Cons)	PC6	4	CT	1	0.2950	0.4416	71	0.67	Dunnett	1.0000
<b>Event (Cons)</b>	<b>PC64</b>	<b>4</b>	<b>CT</b>	<b>1</b>	<b>-2.0618</b>	<b>0.4416</b>	<b>71</b>	<b>-4.67</b>	<b>Dunnett</b>	<b>0.0009</b>
<b>Event (Cons)</b>	<b>PC67</b>	<b>4</b>	<b>CT</b>	<b>1</b>	<b>-2.4976</b>	<b>0.4416</b>	<b>71</b>	<b>-5.66</b>	<b>Dunnett</b>	<b>&lt;.0001</b>
Event (Cons)	PC70	4	CT	1	-0.1381	0.4416	71	-0.31	Dunnett	1.0000
Event (Cons)	PC80	4	CT	1	1.4462	0.4416	71	3.27	Dunnett	0.0803

Event (Cons)	PM1	5	CT	1	0.7087	0.4416	71	1.60	Dunnett	0.9877
Event (Cons)	PM103	5	CT	1	-0.1115	0.4416	71	-0.25	Dunnett	1.0000
Event (Cons)	PM111	5	CT	1	0.5960	0.4416	71	1.35	Dunnett	0.9995
Event (Cons)	PM113	5	CT	1	-0.6251	0.4416	71	-1.42	Dunnett	0.9986
Event (Cons)	PM125	5	CT	1	0.2347	0.4416	71	0.53	Dunnett	1.0000
Event (Cons)	PM127	5	CT	1	0.4647	0.4416	71	1.05	Dunnett	1.0000
Event (Cons)	PM131	5	CT	1	0.01323	0.4416	71	0.03	Dunnett	1.0000
Event (Cons)	PM149	5	CT	1	-0.2395	0.4416	71	-0.54	Dunnett	1.0000
Event (Cons)	PM150	5	CT	1	-0.4999	0.4416	71	-1.13	Dunnett	1.0000
Event (Cons)	PM19	5	CT	1	-0.5664	0.4416	71	-1.28	Dunnett	0.9998
Event (Cons)	PM36	5	CT	1	0.03287	0.4416	71	0.07	Dunnett	1.0000
Event (Cons)	PM37	5	CT	1	-0.2695	0.4416	71	-0.61	Dunnett	1.0000
Event (Cons)	PM61	5	CT	1	-0.6745	0.4416	71	-1.53	Dunnett	0.9944
Event (Cons)	PM7	5	CT	1	-0.2743	0.4416	71	-0.62	Dunnett	1.0000
Event (Cons)	PM74	5	CT	1	0.9441	0.4416	71	2.14	Dunnett	0.7483
Event (Cons)	PM76	5	CT	1	0.8563	0.4416	71	1.94	Dunnett	0.8820
Event (Cons)	PM8	5	CT	1	0.4954	0.4416	71	1.12	Dunnett	1.0000
Event (Cons)	PM93	5	CT	1	-0.3403	0.4416	71	-0.77	Dunnett	1.0000
Event (Cons)	PM98	5	CT	1	-0.05074	0.4416	71	-0.11	Dunnett	1.0000

## B) Relationships between gene expression, budflush, and growth

### Correlation analysis

Data are from all transgenic events including the control (clone 195-529). Mean Julian date and mean net growth, were calculated from two pairs of ramets for each transgenic event, and five pairs of ramets for the control trees. Relative expression of the respective genes was quantified via RT-PCR, as described in Materials and Methods, Chapter 3.

**Table M 3** Correlation analysis for variables relative expression of specific target genes and Julian date/net growth. The Spearman correlation coefficients (r) are shown with the supporting p-values. Significant associations are shown in **bold**.

Relative expression (ln) of target genes/population	Julian date (ln)		Net growth (ln)	
	r	p-value	r	p-value
Native <i>PtCENL-1</i> in RNAi trees	-0.333	0.208	-0.420	0.105
<i>PtCENL-1</i> transgene in 35S:: <i>PtCENL-1</i> trees	<b>0.877</b>	<b>0.0001</b>	-0.392	0.096
Native <i>PtMFT</i> in RNAi trees	-0.025	0.926	0.103	0.704
<i>PtMFT</i> transgene in 35S:: <i>PtMFT</i> trees	0.245	0.327	<b>0.499</b>	<b>0.035</b>

### C) Data on gene expression, budflush, and growth

Relative expression levels of the respective target genes in individual transgenic events/control were based on real-time PCR (RT-PCR). Total RNAs were extracted from a pool of newly flushed, ~1cm leaflets, collected from two ramets per event. Real-time-PCR runs were repeated at least twice for the same cDNA sample with duplicates in each run. Error bars are one standard deviation (SD) over the average from a minimum of four PCR reaction replicates. Data on budflush were scored when the first bud burst in spring 2005 (natural logarithm of Julian date, JD). Data on growth rate were based on volume increment over one growing season (natural logarithm of volume index, NG). Error bars are one SD over the mean of four ramets per event, and ten ramets for non-transgenic control (CT).

**HANNIBAL::*PtCENL-1* (HC) transgenic poplars****Table M 4** Relative expression (RE) of native *PtCENL-1*, mean of Julian date (JD), and mean of net growth (NG) in HANNIBAL::*PtCENL-1* (HC) transgenic poplar trees. RE was re-scaled to the control tree (CT) expression, which was set to 1. Data for JD and NG are in natural logarithm (ln).

<b>Transgenic event</b>	<b>RE ± SD</b>	<b>JD ± SD</b>	<b>NG ± SD</b>
HC178	0.091 ± 0.004	4.590 ± 0.022	4.608 ± 0.348
HC27	0.152 ± 0.022	4.648 ± 0.060	3.622 ± 0.065
HC183	0.224 ± 0.002	4.605 ± 0.000	4.307 ± 0.396
HC191	0.327 ± 0.148	4.622 ± 0.024	4.200 ± 0.098
HC169	0.397 ± 0.117	4.615 ± 0.014	4.010 ± 0.133
HC153	0.451 ± 0.060	4.572 ± 0.026	4.581 ± 0.375
HC14	0.637 ± 0.126	4.588 ± 0.049	3.644 ± 0.012
HC190	0.764 ± 0.051	4.582 ± 0.011	4.920 ± 0.856
HC7	0.867 ± 0.389	4.543 ± 0.015	4.756 ± 0.448
CT	1	4.564 ± 0.016	4.068 ± 0.377
HC20	1.416 ± 0.312	4.572 ± 0.026	4.008 ± 0.134
HC175	1.531 ± 0.254	4.605 ± 0.000	4.005 ± 0.452
HC179	1.697 ± 0.224	4.600 ± 0.014	4.061 ± 0.530
HC36	1.757 ± 0.264	4.564 ± 0.000	3.845 ± 0.000
HC6	1.905 ± 0.510	4.599 ± 0.034	3.850 ± 0.637
HC35	3.029 ± 0.618	4.603 ± 0.018	3.487 ± 0.713

**Table M 5** Relative expression (RE) of native *PtCENL-1* in biological replicates of the suppressed HANNIBAL::*PtCENL-1* (HC) transgenic events. RE was re-scaled to the control tree (CT) expression.

<b>Transgenic event/ramet</b>	<b>RE ± SD</b>
HC178-4	0.198 ± 0.039
HC178-3	0.201 ± 0.002
HC183-1	0.217 ± 0.015
HC183-4	0.258 ± 0.010
HC191-5	0.257 ± 0.019
HC191-3	0.318 ± 0.005
HC169-1	0.424 ± 0.006
HC169-2	0.495 ± 0.008
CT	1

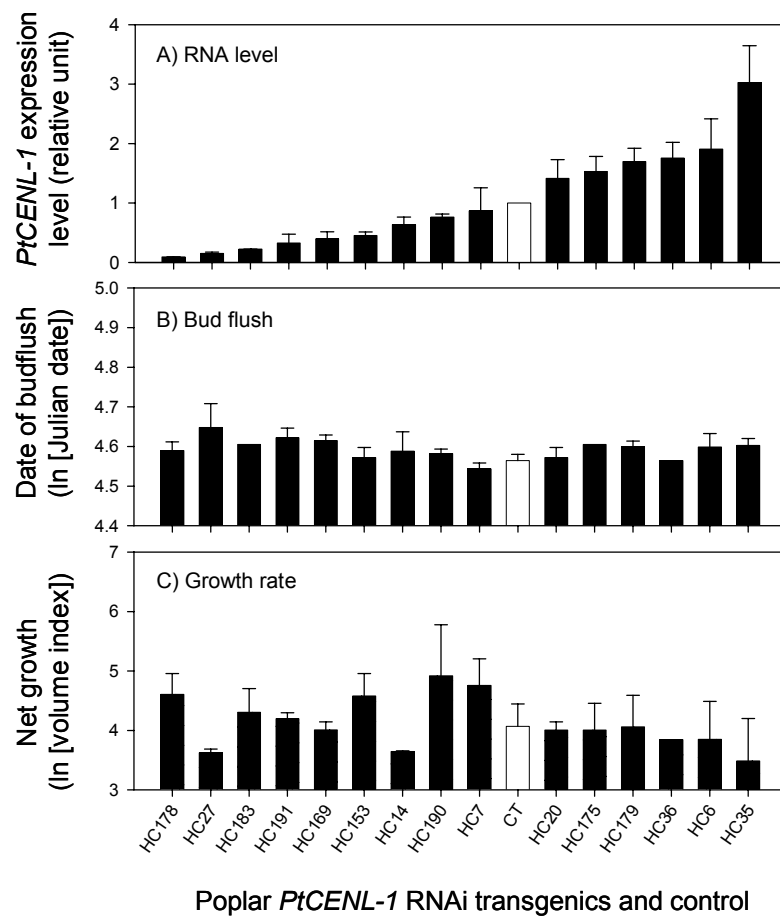

**Figure M 1** Relationship between the expression of native *PtCENL-1* (A) and the timing of budbreak (B) and growth (C) in two-year-old, field-grown transgenic *Populus tremula* x *P. alba*. HC = transgenic events; CT = non-transgenic.

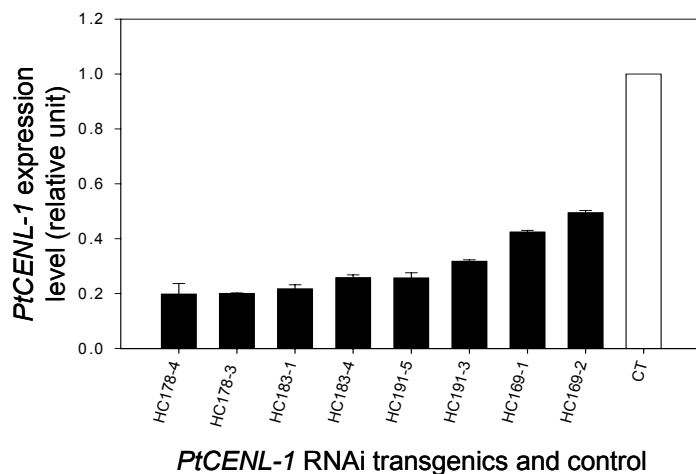
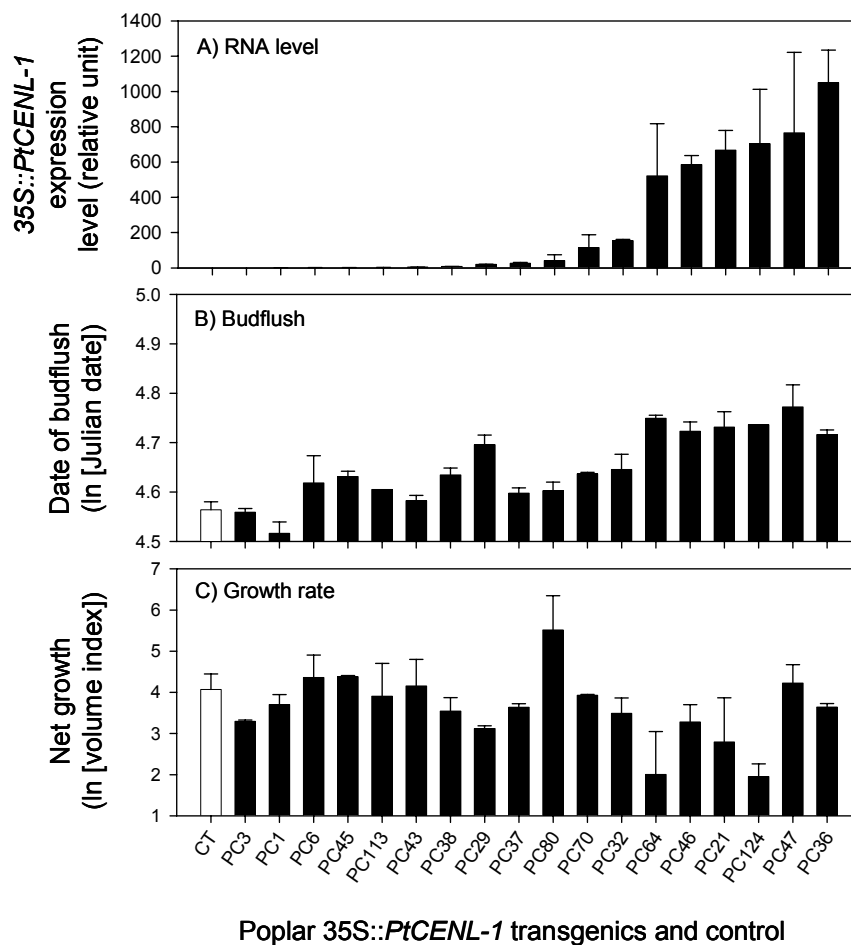

**Figure M 2** Expression levels of native *PtCENL-1* transcript in biological replicates (different ramets) of selected HANNIBAL::*PtCENL-1* trees and non-transgenic controls. HC = transgenic events; CT = non-transgenic.

### **35S::*PtCENL-1* (PC) transgenic poplars**

**Table M 6** Relative expression (RE) of native *PtCENL-1*, mean of Julian date (JD), and mean of net growth (NG) in 35S::*PtCENL-1* (PC) transgenic poplar trees. RE was re-scaled to the transgenic event with the lowest expression (PC3) set to 1.

Transgenic event	RE $\pm$ SD	JD $\pm$ SD	NG $\pm$ SD
CT	0	4.564 $\pm$ 0.016	4.068 $\pm$ 0.377
PC3	1	4.559 $\pm$ 0.007	3.296 $\pm$ 0.030
PC1	1.140 $\pm$ 0.087	4.516 $\pm$ 0.023	3.705 $\pm$ 0.238
PC6	1.594 $\pm$ 0.051	4.618 $\pm$ 0.055	4.363 $\pm$ 0.542
PC45	2.003 $\pm$ 0.230	4.631 $\pm$ 0.011	4.383 $\pm$ 0.027
PC113	2.228 $\pm$ 0.594	4.605 $\pm$ 0.000	3.906 $\pm$ 0.797
PC43	4.152 $\pm$ 0.879	4.582 $\pm$ 0.011	4.154 $\pm$ 0.643
PC38	7.893 $\pm$ 0.309	4.635 $\pm$ 0.014	3.545 $\pm$ 0.326
PC29	20.543 $\pm$ 0.805	4.696 $\pm$ 0.019	3.122 $\pm$ 0.067
PC37	26.929 $\pm$ 4.141	4.598 $\pm$ 0.011	3.638 $\pm$ 0.084
PC80	42.497 $\pm$ 32.869	4.603 $\pm$ 0.018	5.514 $\pm$ 0.833
PC70	115.881 $\pm$ 72.287	4.637 $\pm$ 0.003	3.930 $\pm$ 0.018
PC32	154.418 $\pm$ 6.809	4.646 $\pm$ 0.031	3.493 $\pm$ 0.369
PC64	521.135 $\pm$ 296.750	4.749 $\pm$ 0.006	2.006 $\pm$ 1.039
PC46	586.160 $\pm$ 50.215	4.723 $\pm$ 0.019	3.279 $\pm$ 0.422
PC21	667.576 $\pm$ 112.349	4.732 $\pm$ 0.031	2.796 $\pm$ 1.071
PC124	704.411 $\pm$ 307.757	4.736 $\pm$ 0.000	1.955 $\pm$ 0.305
PC47	766.108 $\pm$ 456.508	4.772 $\pm$ 0.045	4.225 $\pm$ 0.448
PC36	1050.019 $\pm$ 184.317	4.716 $\pm$ 0.009	3.643 $\pm$ 0.086

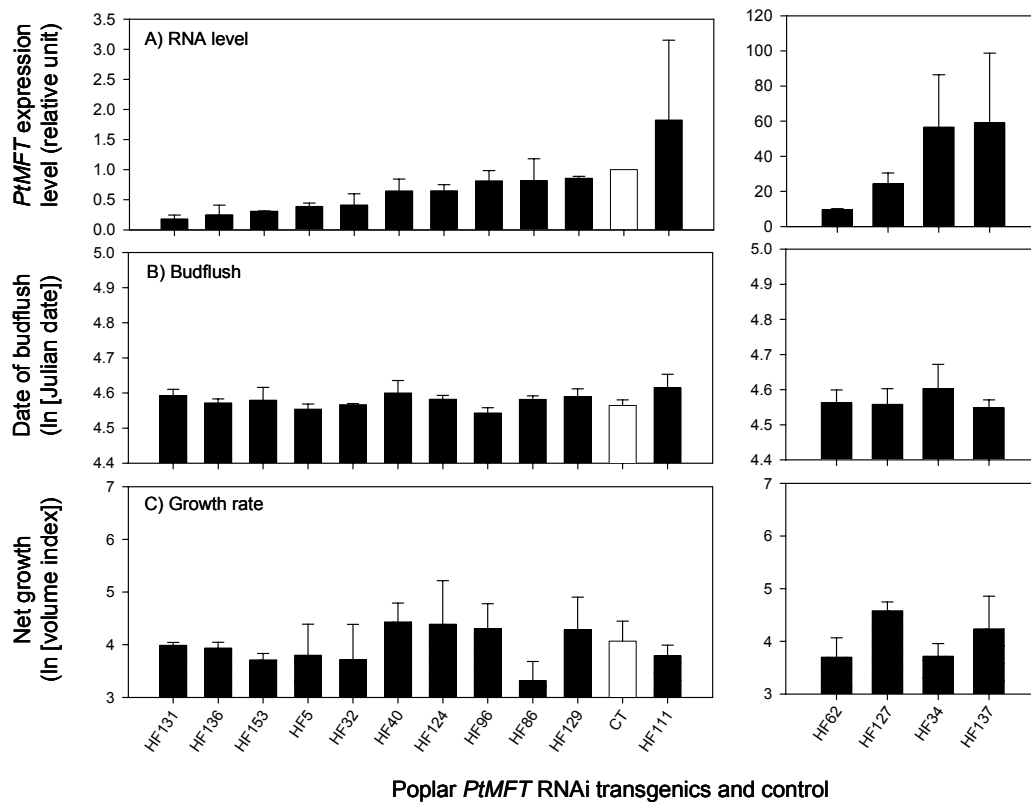

**Figure M 3** Relationship between the expression of *PtCENL-1* transgene (A) and the timing of budbreak (B) and growth (C) in two-year-old, field-grown transgenic *Populus tremula* x *P. alba*. PC = transgenic events; CT = non-transgenic.

**HANNIBAL::*PtMFT* (HF) transgenic poplars**

**Table M 7** Relative expression (RE) of native *PtMFT*, mean of Julian date (JD), and mean of net growth (NG) in HANNIBAL::*PtMFT* (HF) transgenic poplar trees. RE was re-scaled to the non-transgenic control (CT), which was set to 1.

<b>Transgenic event</b>	<b>RE <math>\pm</math> SD</b>	<b>JD <math>\pm</math> SD</b>	<b>NG <math>\pm</math> SD</b>
HF131	0.181 $\pm$ 0.065	4.592 $\pm$ 0.018	3.987 $\pm$ 0.056
HF136	0.251 $\pm$ 0.160	4.572 $\pm$ 0.011	3.937 $\pm$ 0.108
HF153	0.309 $\pm$ 0.005	4.579 $\pm$ 0.036	3.711 $\pm$ 0.121
HF5	0.388 $\pm$ 0.057	4.554 $\pm$ 0.015	3.798 $\pm$ 0.591
HF32	0.413 $\pm$ 0.185	4.567 $\pm$ 0.003	3.715 $\pm$ 0.670
HF40	0.647 $\pm$ 0.196	4.600 $\pm$ 0.036	4.433 $\pm$ 0.357
HF124	0.649 $\pm$ 0.100	4.582 $\pm$ 0.011	4.390 $\pm$ 0.825
HF96	0.813 $\pm$ 0.172	4.543 $\pm$ 0.015	4.304 $\pm$ 0.474
HF86	0.817 $\pm$ 0.363	4.582 $\pm$ 0.010	3.320 $\pm$ 0.360
HF129	0.857 $\pm$ 0.032	4.590 $\pm$ 0.022	4.282 $\pm$ 0.620
CT	1	4.564 $\pm$ 0.016	4.068 $\pm$ 0.377
HF111	1.823 $\pm$ 1.327	4.615 $\pm$ 0.038	3.792 $\pm$ 0.198
HF62	9.511 $\pm$ 0.631	4.563 $\pm$ 0.036	3.700 $\pm$ 0.366
HF127	24.286 $\pm$ 6.172	4.558 $\pm$ 0.044	4.579 $\pm$ 0.168
HF34	56.664 $\pm$ 29.757	4.603 $\pm$ 0.069	3.718 $\pm$ 0.239
HF137	59.085 $\pm$ 39.609	4.548 $\pm$ 0.022	4.237 $\pm$ 0.620

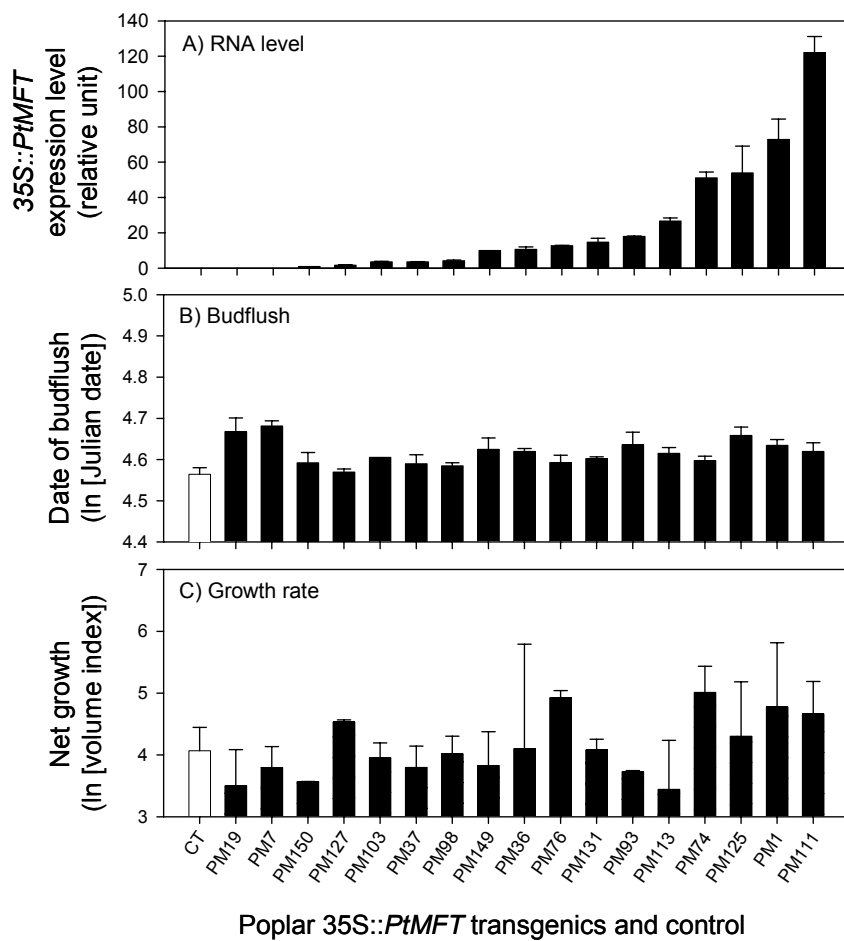

**Figure M 4** Relationship between the expression of native *PtMFT* (A) and the timing of budbreak (B) and growth (C) in two-year-old, field-grown transgenic *Populus tremula* x *P. alba*. HF = transgenic events; CT = non-transgenic.

**35S::*PtMFT* (PM) transgenic poplars**

**Table M 8** Relative expression (RE) of *PtMFT* transgene, mean of Julian date (JD), and mean of net growth (NG) in 35S::*PtMFT* (PM) transgenic poplar trees. RE was re-scaled to the transgenic event with the lowest expression (PM150), which was set to 1. NA = not analyzed.

<b>Transgenic event</b>	<b>RE ± SD</b>	<b>JD ± SD</b>	<b>NG ± SD</b>
CT	0	4.564 ± 0.016	4.068 ± 0.377
PM19	NA	4.668 ± 0.033	3.501 ± 0.585
PM7	NA	4.682 ± 0.012	3.794 ± 0.341
PM150	1	4.592 ± 0.025	3.568 ± 0.001
PM127	1.694 ± 0.289	4.570 ± 0.007	4.533 ± 0.033
PM103	3.586 ± 0.298	4.605 ± 0.000	3.956 ± 0.237
PM37	3.612 ± 0.115	4.590 ± 0.022	3.798 ± 0.346
PM98	4.247 ± 0.270	4.585 ± 0.007	4.017 ± 0.286
PM149	10.091 ± 0.000	4.625 ± 0.028	3.828 ± 0.546
PM36	10.673 ± 1.356	4.620 ± 0.007	4.101 ± 1.690
PM76	12.686 ± 0.249	4.592 ± 0.018	4.924 ± 0.116
PM131	14.774 ± 2.129	4.602 ± 0.004	4.081 ± 0.174
PM93	18.032 ± 0.133	4.636 ± 0.030	3.728 ± 0.018
PM113	26.750 ± 1.703	4.615 ± 0.014	3.443 ± 0.792
PM74	51.143 ± 3.256	4.598 ± 0.011	5.012 ± 0.420
PM125	53.965 ± 15.138	4.659 ± 0.020	4.303 ± 0.881
PM1	72.951 ± 11.395	4.635 ± 0.014	4.777 ± 1.038
PM111	122.102 ± 8.969	4.620 ± 0.021	4.664 ± 0.524



**Figure M 5** Relationship between the expression of *PtMFT* transgene (A) and the timing of budbreak (B) and growth (C) in two-year-old, field-grown transgenic *Populus tremula* x *P. alba*. PM = transgenic events; CT = non-transgenic.

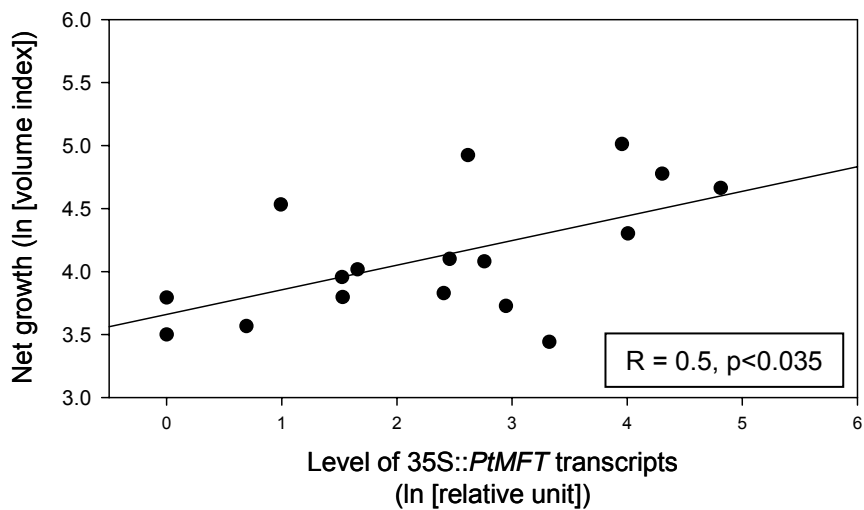

**Figure M 6** Relationship between *PtMFT* transgene overexpression and net growth in two-year-old, field-grown transgenic *Populus tremula* x *P. alba*. Relative expression levels of 35S::*PtMFT* in individual transgenic events were based on real-time RT-PCR (RT-PCR). Total RNAs were extracted from a pool of newly flushed ~1cm leaflets collected from two ramets per transgenic event. Real-time PCR was repeated at least twice for each cDNA sample. Net growth (ln) over four ramets per event, was based on tree growth during one growing season.

## **Appendix N LOCATION OF PRIMERS, DNA AND RNA SAMPLES, AND ELECTRONIC FILES IN THE LABORATORY**

All primers, plasmids, construct intermediates, and cDNA templates are stored in Nalgene/cardboard boxes, labeled as "Rozi – Flowering time genes" and stored at –20 °C in Refrigerator #15, Richardson Hall, room 385. Total RNA samples are stored in cardboard boxes, labeled as "Rozi – total RNA 717" and "Rozi – total RNA Arabidopsis" at –85 °C in the upright freezer (Nuair), Richardson Hall, room 386.

All plasmids and intermediates were cloned into *E. coli* DH5 $\alpha$  (Gibco BRL). Glycerol stocks are stored in Nalgene cryoboxes at –85 °C in the chest freezer (Nuair), Richardson Hall, room 386. Proper documentation on their locations can be found in the electronic file at: T:\Groups\tgerc\GLYCEROL STOCKS.

Primer sequence can be found in the central electronic location at:

T:\Groups\tgerc\PRIMERS\primer list.xls.

*PtCENL-1* and *PtMFT* genomic and coding sequences can be found in the Clone Manager format at T:\Groups\tgerc\MAPS.

An electronic copy of this thesis is stored at T:\Groups\tgerc\thesis\Rozi\_PhD and is accessible to the public at

[http://zircote.forestry.oregonstate.edu/tgbb/thesis/Rozi\\_PhD](http://zircote.forestry.oregonstate.edu/tgbb/thesis/Rozi_PhD). Another electronic copy is deposited at DSpace@OSU, Valley Library, Oregon State University, Corvallis, OR.